



OPHTHALMIC INSTRUMENTS
CATALOGUE



SURGICAL
ESSENCE

TABLE OF CONTENTS



01- Speculum	01-03
02- Scissors	04-06
03- Forceps	07-16
04- Needle holders	17-18
05- Choppers	19-00
06- Spatulas	20-21
07- Curettes	22-00
08- Fixation Rings	23-00
09- Corneal Markers	24-00
10- Hooks	25-27
11- I-A Systems	28-29
12- Manipulators	30-32
13- Lacrimal Instruments	33-36
14- Cannulas	37-41
15- Sterilization Boxes	42-00



SURGICAL
ESSENCE

SPECULUMS

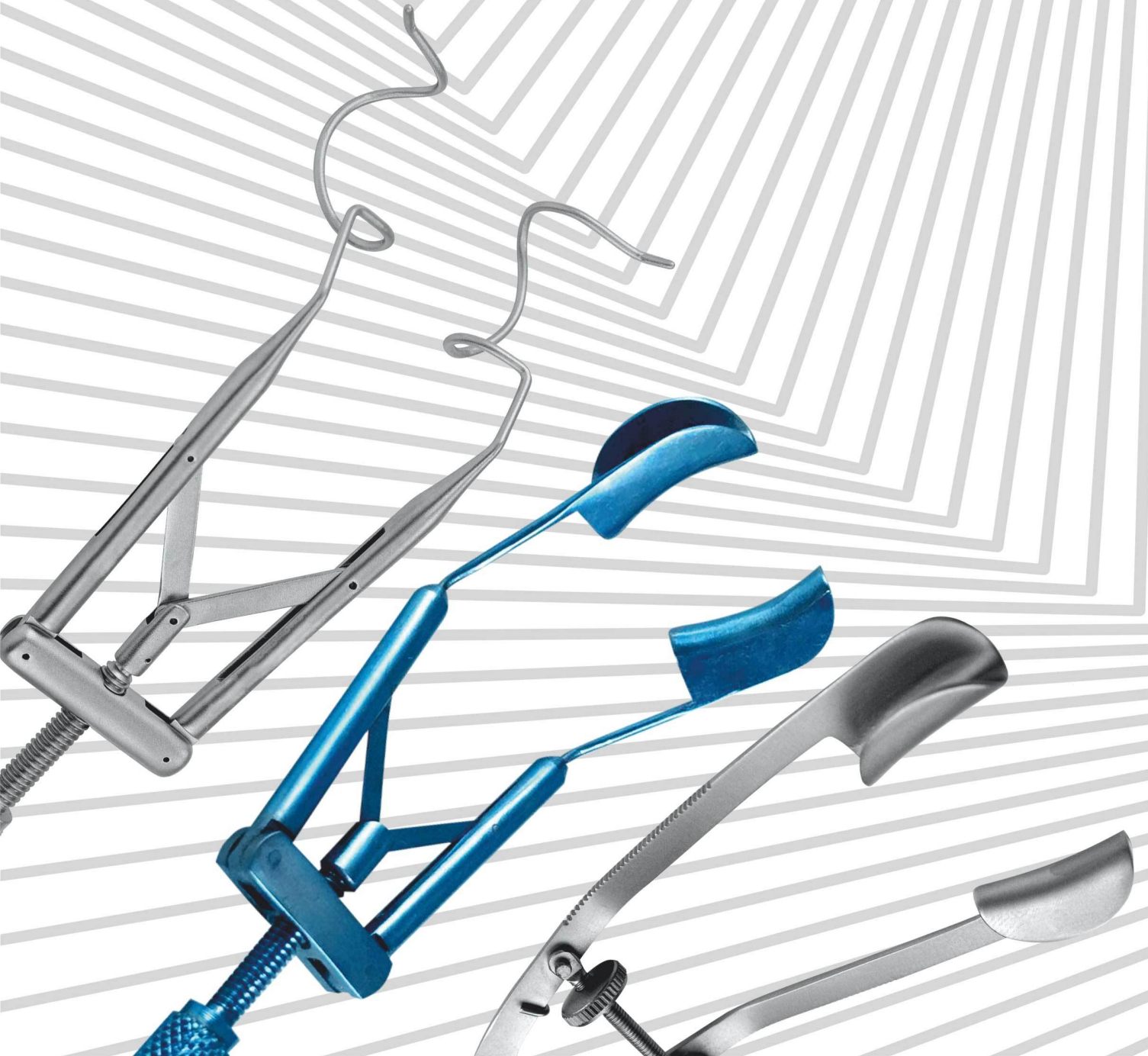



Item #: 08146

Name: Lieberman Speculum V
Wire Large Temporal Fit
Details: Adjustable eye speculum
with Kratz style open wire blades
Temporal, Stainless Steel

Item #: 08147

Name: Steinert Speculum, Nasal Fit
Details: Adjustable eye speculum
with Kratz style open wire blades
Nasal, Stainless Steel

Item #: 08152

Name: Steinert LASIK Hansa / Moria
Speculum
Details: Temporal, Stainless Steel



Item #: 08157

Name: Lieberman Kratz-Style
Speculum
Details: Adjustable eye speculum
with Kratz style open wire blades
Temporal, Stainless Steel

Item #: 08157S

Name: Lieberman Kratz-Style Speculum,
14mm Blades
Details: Adjustable eye speculum
with Kratz style open wire blades
Temporal, Stainless Steel

Item #: 5678

Name: Lieberman Speculum Solid Large
Details: Thin, solid blades
with non-reflective finish
10mm Solid Blades / 14mm Solid Blades



Item #: 5014
Name: Temporal Speculum Solid Blades
Details: Spring on nasal side

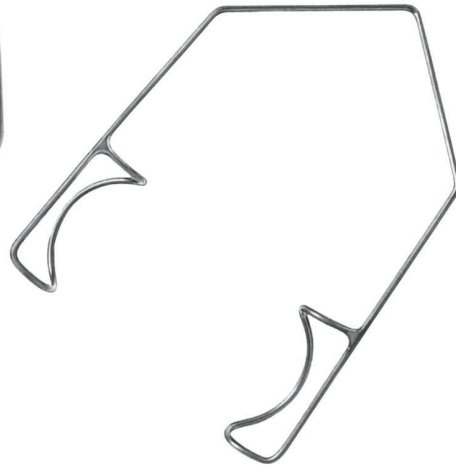

Item #: 5000
Name: Barraquer Wire Speculum Small
Details: 10mm Blades / 15mm Blades

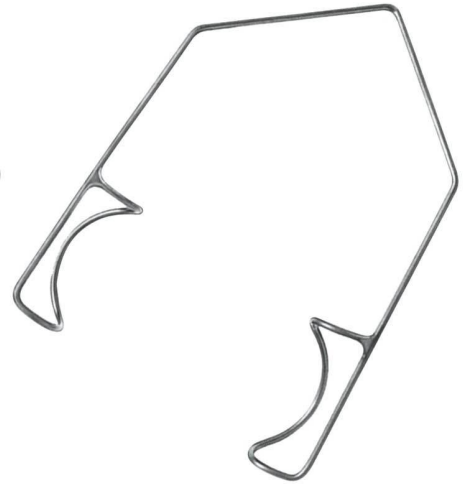

Item #: 5010
Name: Barraquer Wire Speculum Large
Details: 10mm Blades / 15mm Blades

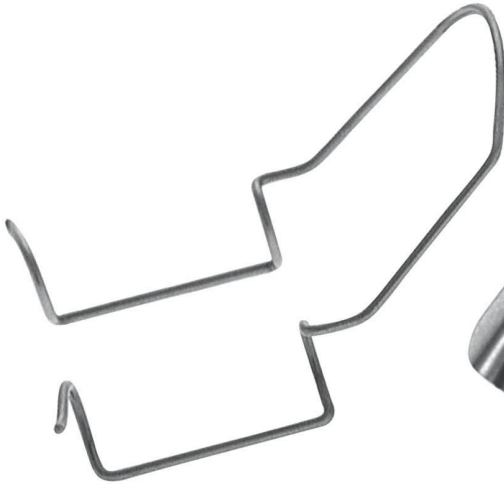

Item #: 5015
Name: Temporal Speculum Open Wire
Details: Spring on nasal side



Item #: 5020
Name: Barraquer Speculum Solid Small
Details: Solid blades



Item #: 5030
Name: Barraquer Speculum Solid Large
Details: Solid blades

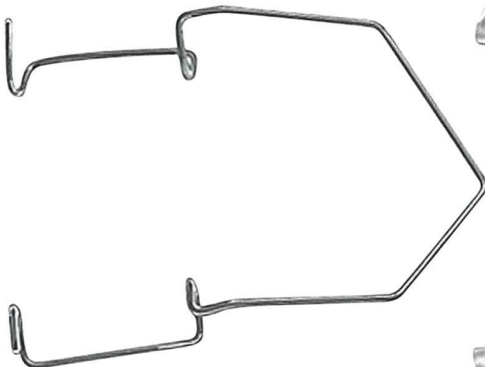

Item #: 5051
Name: Kratz-Barraquer Speculum Small
Details: Open blades; for unobstructed access to the cataract incision with phaco or I/A tip



Item #: 5300
Name: Sauer Infant Speculum
Details: For Infants 11mm Blades/ for premature infants 2mm Blades

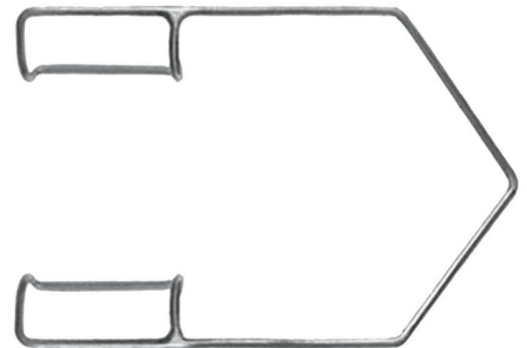

Item #: 5355
Name: Barraquer Infant Wire Speculum
Details: Delicate wire speculum with 9mm blades

Also Available in Titanium



Item #: 5401
Name: Cook Eye Speculum
Details: Eye speculum with locking screw



Item #: 5406
Name: Murdoch Eye Speculum
Details: Eye speculum with locking screw



Item #: 5411
Name: Mellinger Phaco Speculum
Details: 15mm open blades



Item #: 5500
Name: Williams Eye Speculum Small
Details: Eye speculum with locking screw



Item #: 5600
Name: Lancaster Eye Speculum
Details: Eye speculum featuring adjustable mechanism with locking nut and 16mm solid blades



Item #: 5620
Name: Lester-Burch Eye Speculum
Details: Eye speculum featuring adjustable mechanism with locking screw and solid blades with flanges for retaining eye lashes



Item #: 5670
Name: Lieberman Speculum K-Wire Small
Details: Adjustable eye speculum with Kratz style open wire blades



Item #: 5673
Name: Thorlakson Eye Speculum
Details: 11mm rounded wire blades designed to accommodate the suction ring of the FEMTO LDV (TM) laser



Item #: 5675
Name: Lieberman Speculum V-Wire
Details: 15mm V-shaped blades



SURGICAL
ESSENCE

SCISSORS

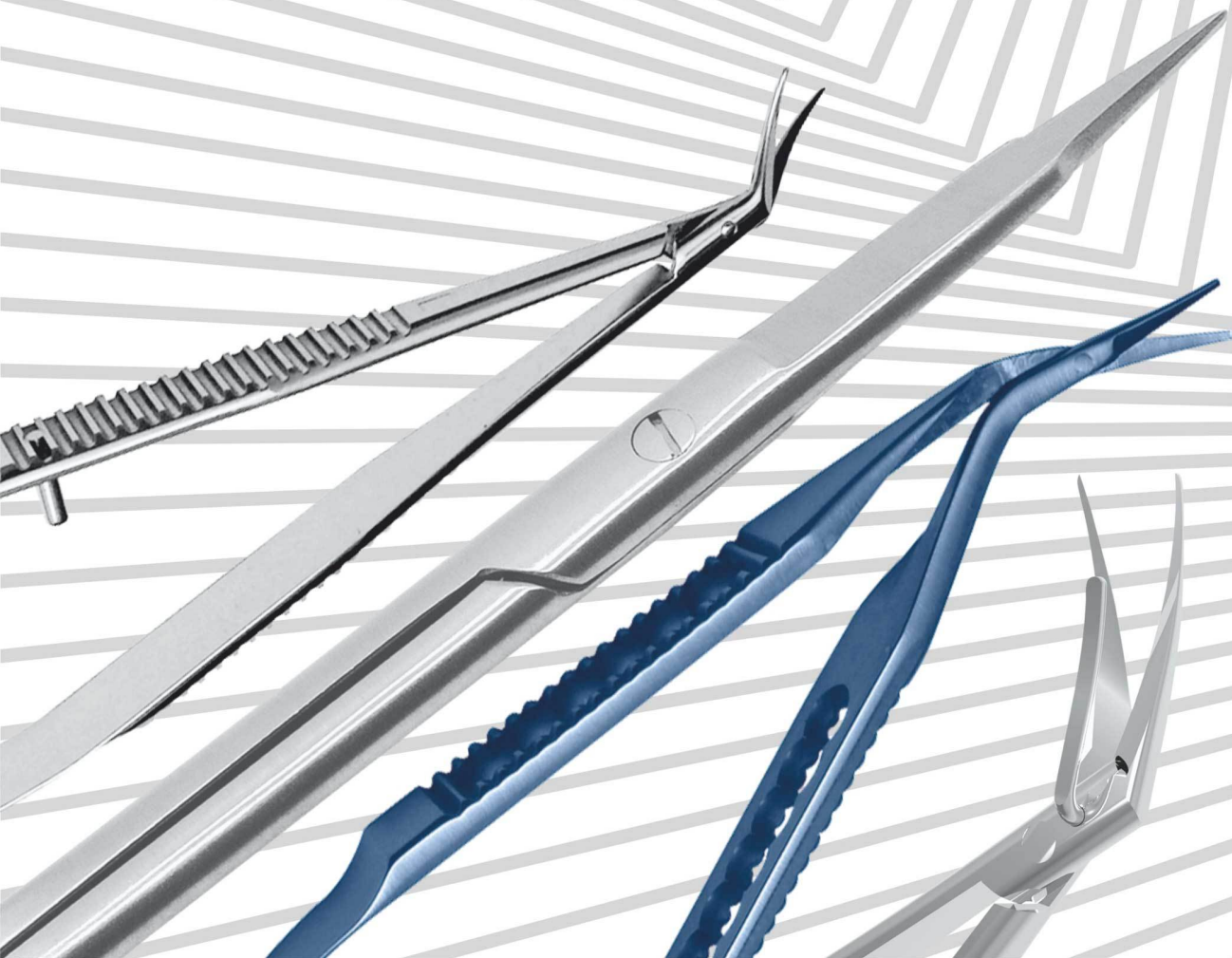

Scissors



Item #: 03109
Name: Stevens Tenotomy Scissors Curved, Blunt
Details: Standard blades with blunt tips and ribbon type handle, 3 3/4" Curved, stainless steel

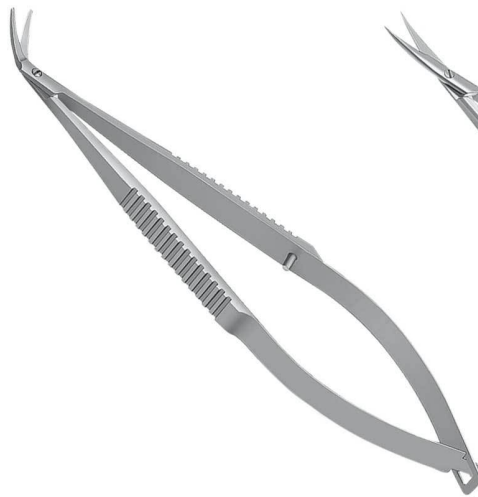

Item #: 03230
Name: Troutman-Katzen Scissors, Curved, Small, RT
Details: Corneal transplant scissors with stop; strong curve, small blades Curved, stainless steel

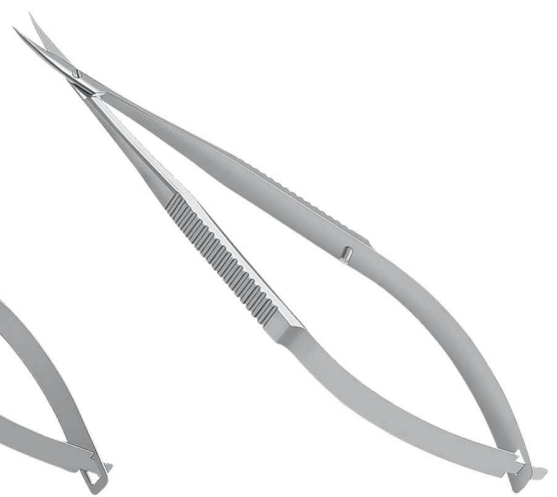

Item #: 03333
Name: Iris Scissors, Curved, Small, Sharp
Details: Curved, small blades with sharp tips Curved, stainless steel



Item #: 03403
Name: Fine Stitch Scissors, Straight, Sharp
Details: Straight, medium blades with sharp tips Straight, stainless steel

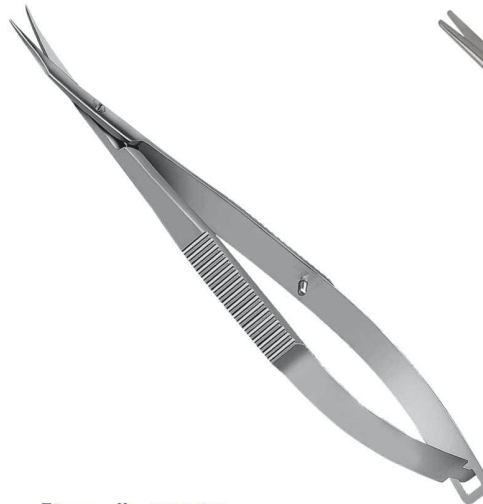

Item #: 03405
Name: Westcott Stitch 4 1/2", Cvd Sharp Points
Details: Curved, small blades with very sharp pointed tips Curved, stainless steel



Item #: 03609
Name: Strabismus Scissors, 4 Straight
Details: Blunt tips Straight, stainless steel



Item #: 2200
Name: Castroviejo Scissors Curved Small
Details: Universal corneal scissors; curved, blunt tips



Item #: 2240
Name: Castroviejo Scissors Curved Large
Details: Universal corneal scissors; curved, blunt tips



Item #: 2850
Name: Castroviejo Scissors Angled Medium
Details: Keratoplasty scissors angled to side with blunt tips and medium blades



Item #: 3004
Name: Westcott Tenotomy Scissors Medium
Details: Curved, medium blades with blunt tips



Item #: 3100
Name: Westcott Tenotomy Scissors Right
Details: Curved, standard blades with blunt tips



Item #: 4100
Name: Westcott Stitch Scissors
Details: Curved, standard blades with very sharp pointed tips



Item #: 4500
Name: Fine Stitch Scissors Medium Straight
Details: Straight, medium blades with sharp tips



Item #: 4510
Name: Fine Stitch Scissors Medium Curved
Details: Curved, medium blades with sharp tips



Item #: 5000
Name: Vannas Scissors Straight
Details: 5mm long blades with sharp tips



Item #: 5010
Name: Vannas Scissors Curved
Details: 5mm long blades with sharp tips



Item #: 5200
Name: Scissors Straight Horizontal 23 Gauge
Details: Stainless steel construction with auto clavable, serrated plastic handle; 23 gauge shank



Item #: 5240
Name: Scissors Angled 60 Degrees Vertical 23 Gauge
Details: Stainless steel construction with auto clavable, serrated plastic handle; 23 gauge shank



Also Available in Titanium

Scissors



Item #: 5250

Name: Scissors Angled 80 Degrees Vertical 23 Gauge
Details: Stainless steel construction with auto clavable, serrated plastic handle; 23 gauge shank



Item #: 5300

Name: Scissors Horizontal Straight 23 Gauge
Details: Horizontal, straight, 23 gauge

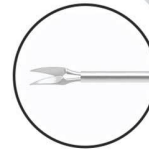
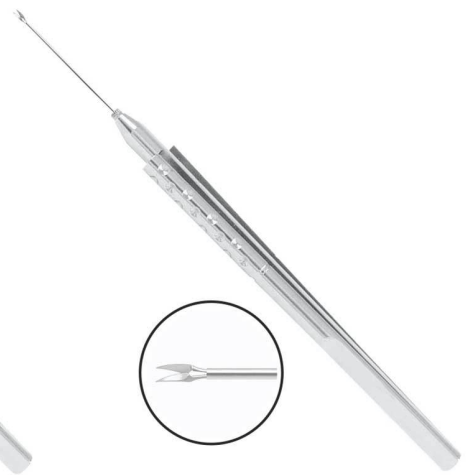

Item #: 5310

Name: Scissors Horizontal Curved 23 Gauge
Details: Horizontal, curved, 23 gauge



Item #: 5320

Name: Scissors Horizontal 45 Degrees 23 Gauge
Details: Horizontal, angled 45 degrees, 23 gauge



Item #: 5330

Name: Scissors Vertical 40 Degrees 23 Gauge
Details: Vertical, 40 degrees, 23 gauge

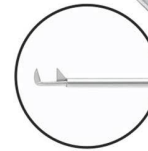

Item #: 5340

Name: Scissors Vertical 80 Degrees 23 Gauge
Details: Vertical, 80 degrees, 23 gauge



Item #: 7200

Name: Eye Scissors Delicate Straight
Details: Small, delicate blades with pointed tips



Item #: 7400

Name: Eye Scissors Standard Straight
Details: Standard blades with pointed tips



Item #: 9000

Name: Knapp Strabismus Scissors Straight
Details: Blunt tips

Forceps

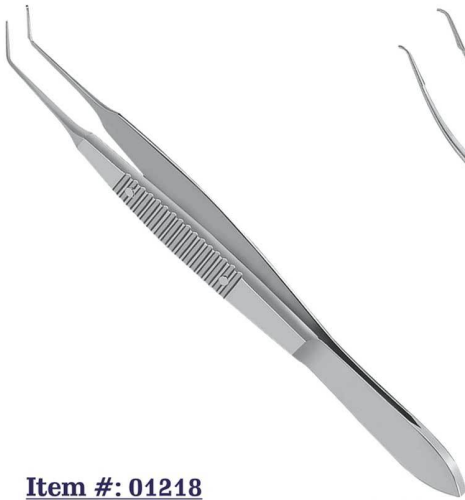

Item #: 01218
Name: McPherson Forceps, 0.12mm, Angled
Details: 1x2 teeth with tying platform
 12mm, 1x2 teeth, Angled, Stainless Steel

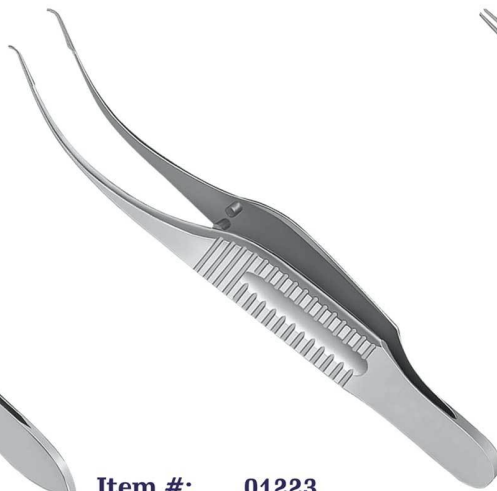

Item #: 01223
Name: Colibri Forceps W/ Platform
Details: 1x2 teeth with tying platform
 3mm, 1x2 teeth, Stainless Steel



Item #: 01254
Name: Castroviejo Corneal Forceps 12mm Wide Handle
Details: 1x2 teeth with tying platform
 12mm, Wide Handle, Stainless Steel



Item #: 01255
Name: Castroviejo Corneal Forceps
 3mm Wide Handle
Details: 1x2 teeth with tying platform
 3mm, Wide Handle, Stainless Steel



Item #: 01259
Name: Castroviejo Colibri Corneal Forceps
 12mm Wide Handle
Details: 1x2 teeth with tying platform
 12mm, Wide Handle, Stainless Steel



Item #: 01413
Name: Utrata Capsulorrhexis Forceps
 Flat Handle
Details: Very delicate, triangular grasping
 tips Flat Handle.

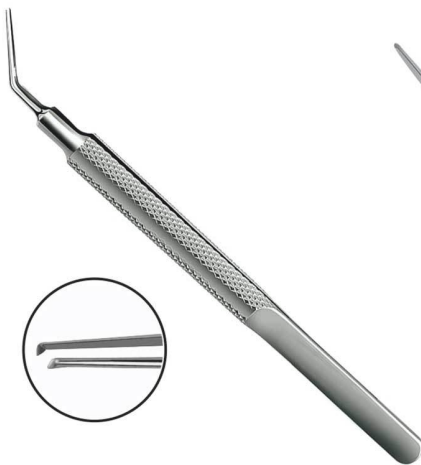

Item #: 01414
Name: Utrata Capsulorrhexis Forceps
 Round Handle
Details: Very delicate, triangular grasping tips
 Round Handle

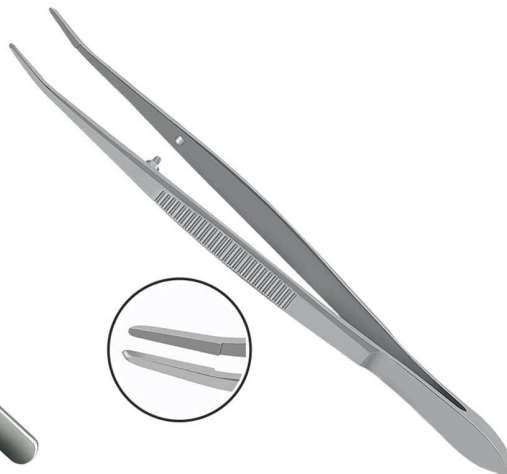

Item #: 01602
Name: Barraquer Cilia Forceps
Details: Lightly angled, textured jaws
 provide superior grasping capabilities

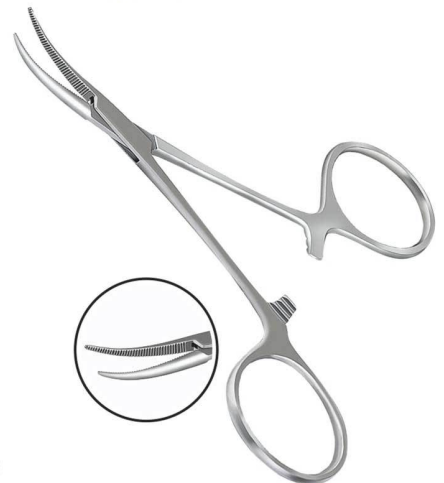

Item #: 5019
Name: Hartman Mosquito Forceps, Curved
Details: Extra delicate, 3 1/2" long
 Curved, Stainless Steel



Item #: 5026

Name: Halsted Mosquito Forceps, Curved, X-Delicate

Details: Extra delicate, 5" long Curved, Stainless Steel



Item #: 7504

Name: Backhaus Towel Clamp

Details: 3.5, Stainless Steel



Item #: 1500

Name: Colibri Forceps 0.12mm Teeth

Details: Very delicate, 1x2 teeth, 0.12mm



Item #: 1522

Name: Dyson-Colibri Forceps Short

Details: Very delicate, 1x2 teeth, 0.12mm with tying platform, short tips and extremely thin shanks

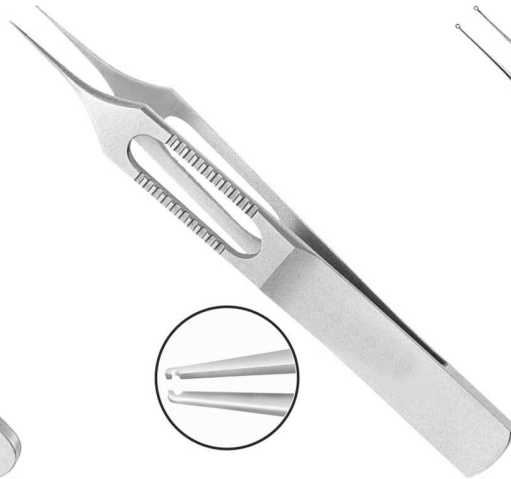

Item #: 1718

Name: Hoskin #18 Forceps Straight

Details: Straight with fine grooved tips



Item #: 1820

Name: Fechtner Conjunctiva Forceps

Details: Very delicate, ring shaped tips with tying platform



Item #: 1900

Name: Castroviejo-Colibri Forceps

Details: Very delicate, 1x2 teeth, 0.12mm

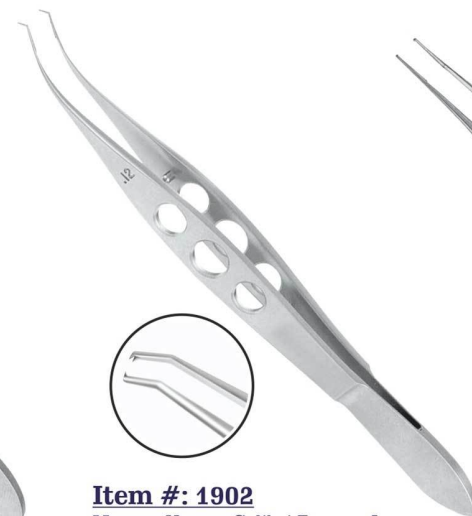

Item #: 1902

Name: Harms-Colibri Forceps Long

Details: Very delicate, 1x2 teeth, 0.12mm with tying platform



Item #: 2020

Name: Bonn Forceps Long 0.12mm

Details: 1x2 teeth, 0.12mm with tying platform

Also Available in Titanium

Forceps



Item #: 2300
Name: McPherson Forceps 1X2 Teeth Straight
Details: 1x2 teeth, 0.4mm with tying platform



Item #: 2310
Name: McPherson Forceps 1X2 Teeth Angled
Details: 1x2 teeth, 0.4mm with tying platform



Item #: 2330
Name: Kelman-McPherson Forceps 1X2 Teeth
Details: 8mm long jaws, 1x2 teeth, 0.3mm



Item #: 2500
Name: Castroviejo Forceps 0.12mm
Details: 1x2 teeth with tying platform



Item #: 2510
Name: Castroviejo Forceps 0.3mm
Details: 1x2 teeth with tying platform



Item #: 2520
Name: Castroviejo Forceps 0.5mm
Details: 1x2 teeth with tying platform



Item #: 2530
Name: Castroviejo Forceps 0.9mm
Details: 1x2 teeth with tying platform

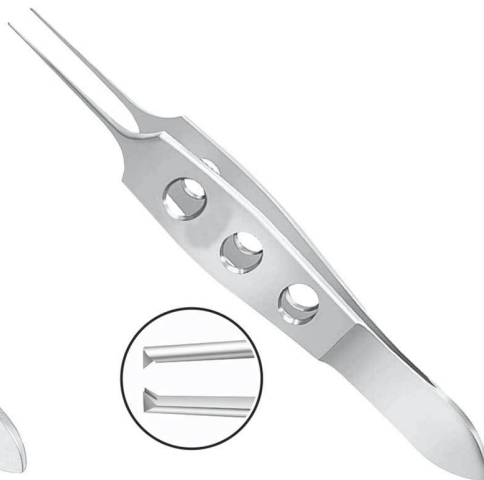

Item #: 3500
Name: Bishop-Harmon Forceps Delicate
Details: 1x2 teeth

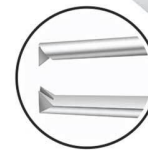

Item #: 3510
Name: Bishop-Harmon Forceps Standard
Details: 1x2 teeth

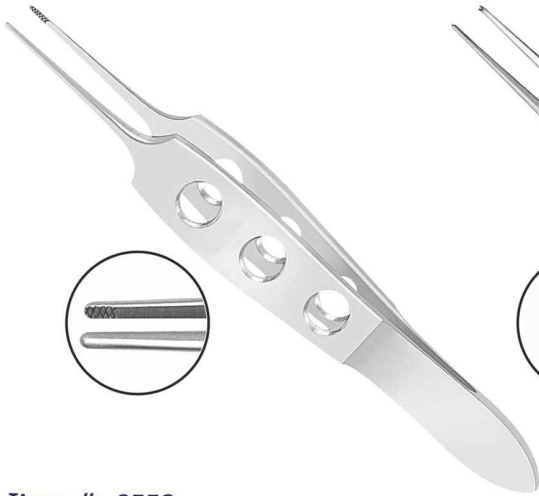

Item #: 3550
Name: Bishop-Harmon Forceps Serrated
Details: Criss-cross serrated tips

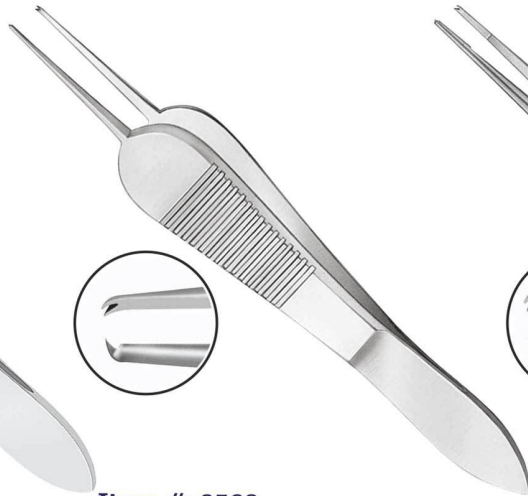

Item #: 3560
Name: Sauer Fixation Forceps 1X2 Teeth
Details: 1x2 teeth, 0.3mm

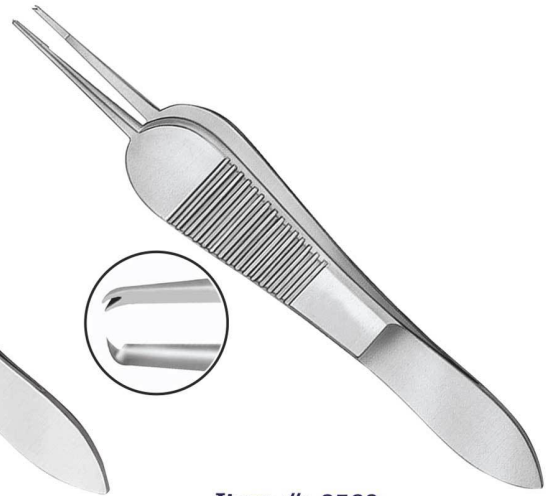

Item #: 3562
Name: Manhattan Eye & Ear Forceps
Details: 1x2 teeth, 0.3mm



Item #: 4000
Name: Dressing Forceps Delicate Straight
Details: Serrated, delicate



Item #: 4010
Name: Dressing Forceps Delicate Curved
Details: Serrated, delicate

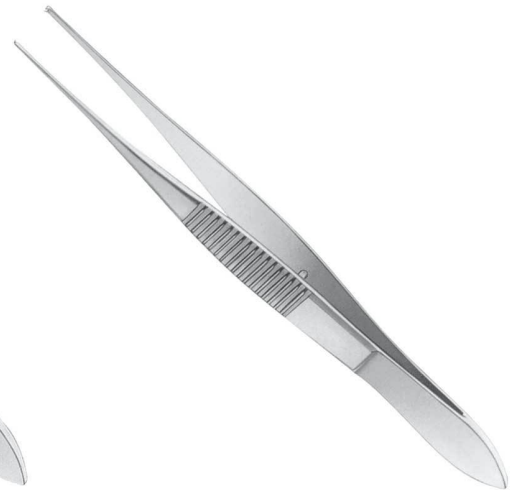

Item #: 4100
Name: Tissue Forceps Delicate 1X2 Teeth Str
Details: 1x2 teeth, delicate



Item #: 4110
Name: Tissue Forceps Delicate 1X2 Teeth Curved
Details: 1x2 teeth, delicate

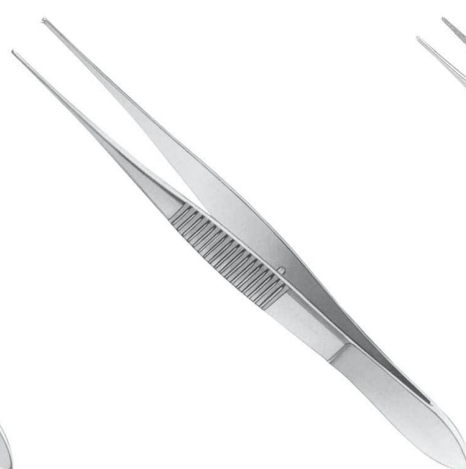

Item #: 4140
Name: Tissue Forceps Standard 1X2 Teeth Str
Details: 1x2 teeth, standard



Item #: 4150
Name: Adson Dressing Forceps Serrated Delicate
Details: Straight, 5" (125mm) long with serrated jaws

Also Available in Titanium

Forceps

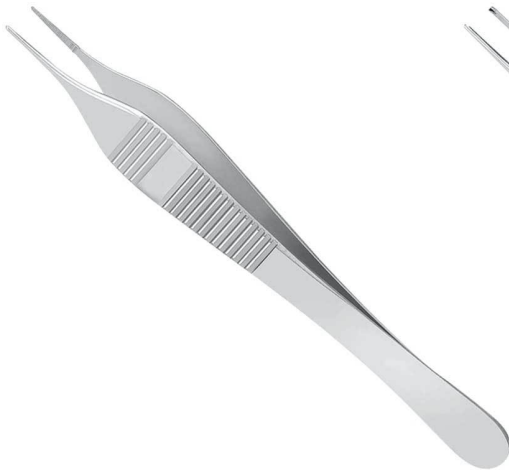

Item #: 4152
Name: Adson Dressing Forceps Serrated Standard
Details: Straight, 5" (125mm) long with serrated jaws

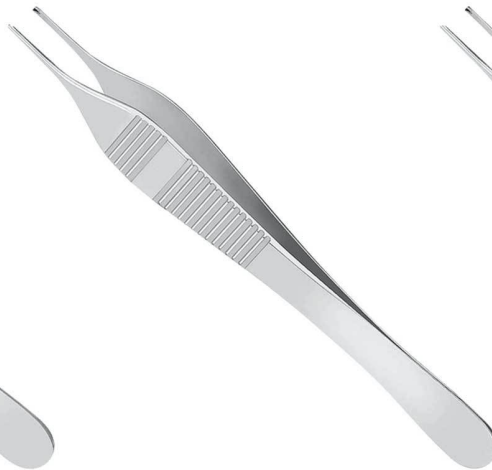

Item #: 4170
Name: Adson Tissue Forceps 1X2 Teeth Delicate
Details: Straight, 5" (125mm) long with 1x2 teeth

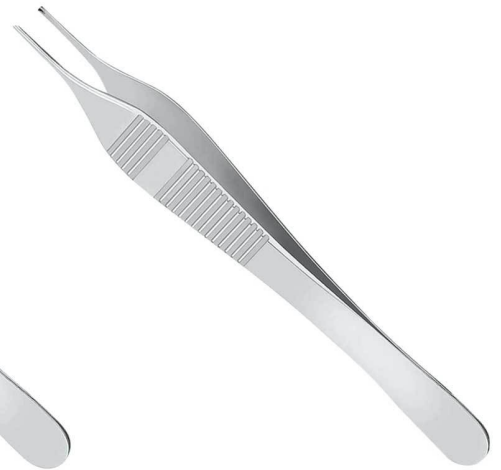

Item #: 4172
Name: Adson Tissue Forceps 1X2 Teeth Standard
Details: Straight, 5" (125mm) long with 1x2 teeth

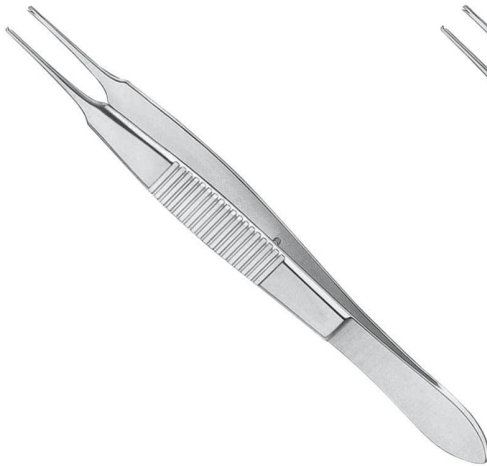

Item #: 4300
Name: Lester Fixation Forceps 1X2 Teeth
Details: Straight, 1x2 teeth

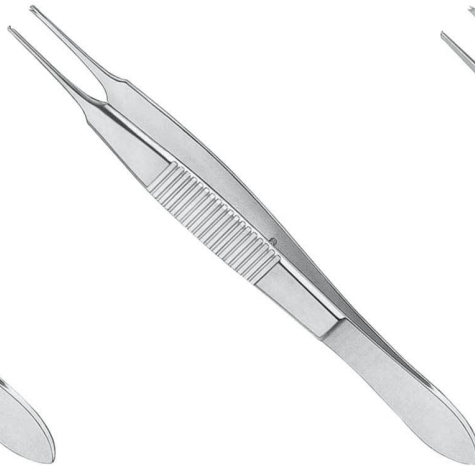

Item #: 4320
Name: Lester Fixation Forceps 2X3 Teeth
Details: Straight 2x3 teeth



Item #: 4500
Name: Bracken Fixation Forceps 1X2 Teeth
Details: 1x2 teeth

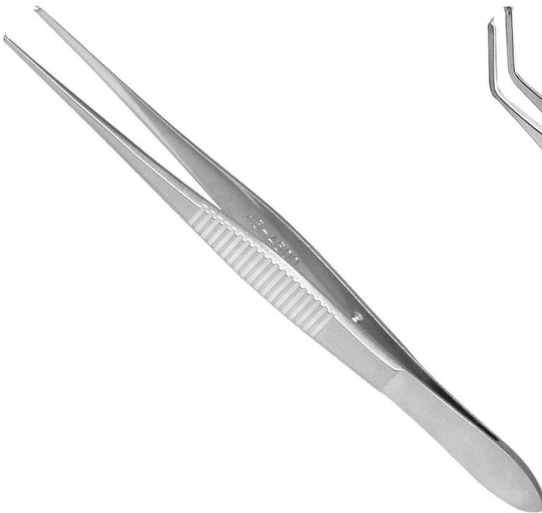

Item #: 4550
Name: Elschning Fixation Forceps
Details: 1x2 teeth



Item #: 4700
Name: Troutman Superior Rectus Forceps
Details: 1x2 teeth, angled



Item #: 5000
Name: McPherson Tying Forceps Straight
Details: 5mm long tying platforms; for 8-0 to 11-0 sutures

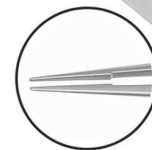

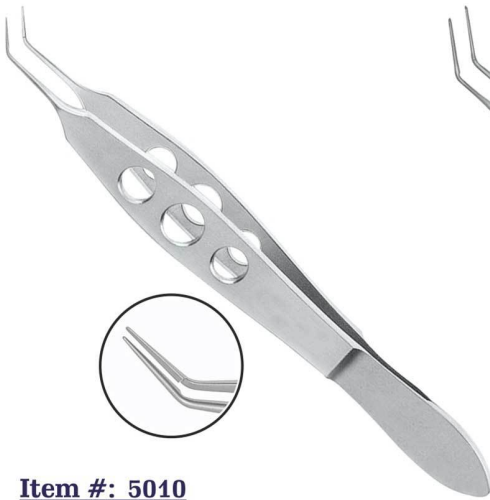

Item #: 5010

Name: McPherson Tying Forceps Angled

Details: 5mm long tying platforms; for 8-0 to 11-0 sutures



Item #: 5030

Name: KELMAN-MCPHERSON FORCEPS ANG

Details: Angled, 7.5mm long tying platforms



Item #: 5050

Name: Gaskin Fragment Forceps

Details: Angled, 11mm long smooth jaws



Item #: 5081

Name: Utrata Capsulorrhexis Forceps

Details: Very delicate, triangular grasping tips and extremely thin 11mm long shanks



Item #: 5082

Name: Utrata Forceps Round Handle

Details: Round handle with guide pin alignment featuring very delicate, triangular grasping tips and extremely thin 11mm long shanks



Item #: 5083

Name: Neyvas Capsulorrhexis Forceps

Details: Cystotome shaped tips with extremely thin 11mm long shanks; for penetrating and grasping the anterior capsule

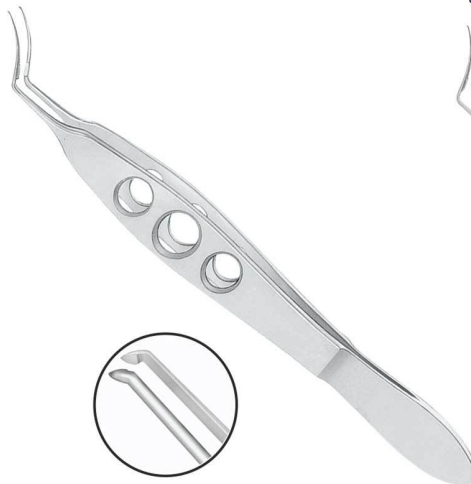

Item #: 5084

Name: Masket Capsulorrhexis Forceps

Details: Very delicate, triangular grasping tips and extremely thin 11mm long vaulted shanks



Item #: 5086

Name: Masket Capsulorrhexis Forceps Round Handle

Details: Round handle with guide pin featuring very delicate, triangular grasping tips and extremely thin 11mm long vaulted shanks

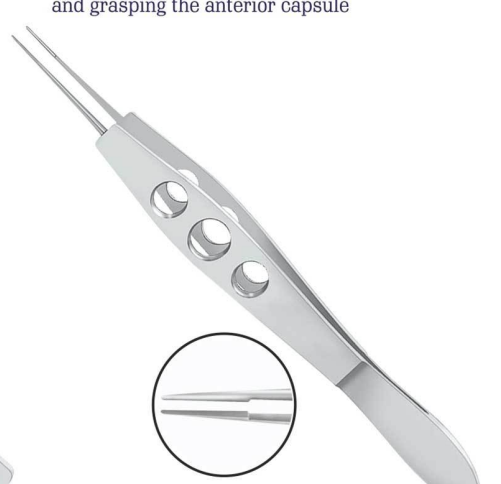

Item #: 5200

Name: Jaffe Tying Forceps Straight

Details: Very delicate, smooth jaws and 6mm long platform; for 8-0 to 11-0 sutures

Also Available in Titanium

Forceps



Item #: 5210
Name: Jaffe Tying Forceps Curved
Details: Very delicate, smooth jaws and 6mm long platform; for 8-0 to 11-0 sutures

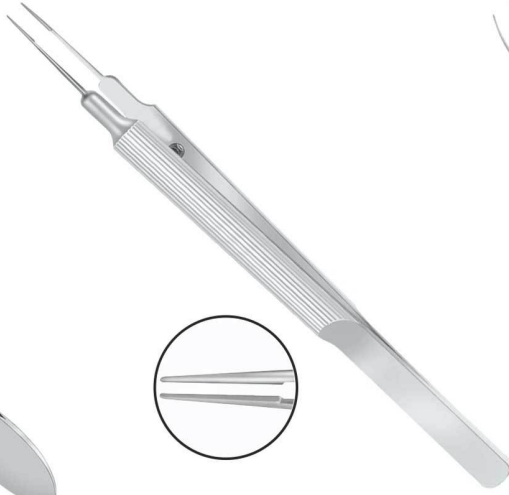

Item #: 5220
Name: Tennant Tying Forceps Straight
Details: Round handle with guide pin featuring extra delicate, smooth jaws and 6mm long platform; for 9-0 to 11-0 sutures



Item #: 5230
Name: Tennant Tying Forceps Curved
Details: Round handle with guide pin featuring extra delicate, smooth jaws and 6mm long platform; for 9-0 to 11-0 sutures



Item #: 5400
Name: Harms Tying Forceps Straight
Details: Standard, smooth jaws; for 7-0 to 9-0 sutures



Item #: 5410
Name: Harms Tying Forceps Curved
Details: Standard, smooth jaws; for 7-0 to 9-0 sutures



Item #: 6510
Name: Jewelers Forceps #1 Straight
Details: Standard, straight



Item #: 6520
Name: Jewelers Forceps #3-C Straight
Details: Delicate, straight



Item #: 6530
Name: Jewelers Forceps #3 Straight
Details: Delicate, straight



Item #: 6540
Name: Jewelers Forceps #4 Straight
Details: Delicate, straight



Item #: 6500
Name: Utility And Splinter Forceps #H



Item #: 6550
Name: Jewelers Forceps #5 Straight
Details: Extra delicate, straight



Item #: 6560
Name: Jewelers Forceps #5 Angled
Details: Extra delicate, angled



Item #: 6570
Name: Jewelers Forceps #7 Curved
Details: Standard, curved

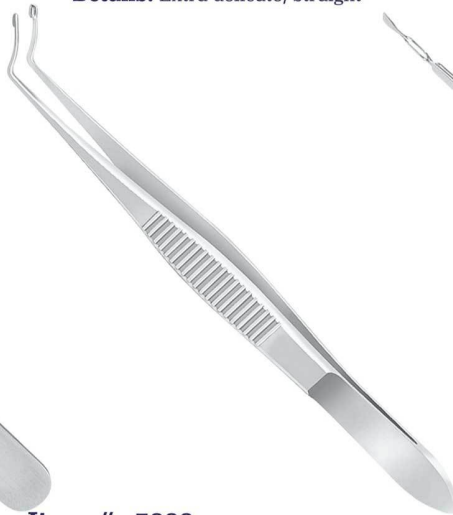

Item #: 7000
Name: Arruga Capsule Forceps



Item #: 7232
Name: Akahoshi Combo Prechopper
Details: For cracking, dividing and rotating both hard and soft nuclei without sculpting



Item #: 7244
Name: Dodick Nucleus Cracker
Details: Cross-action longitudinally serrated, paddle shaped jaws; for cracking the nucleus through a 3.0mm incision

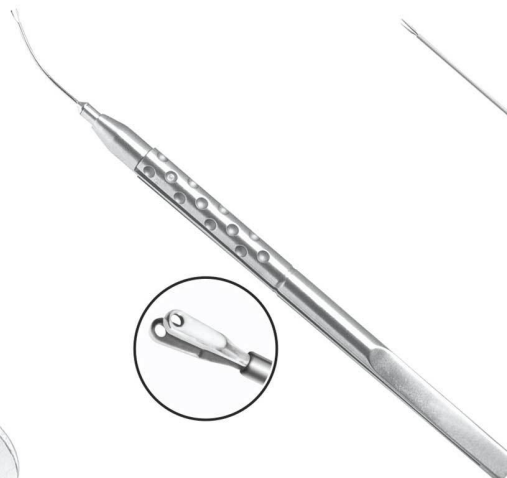

Item #: 7570
Name: Donnenfeld Micro IOL Holding Forceps
Details: 21 gauge, blunt, paddle-shaped tips with central hole for traction and visibility; for grasping a soft IOL during cutting and explanation

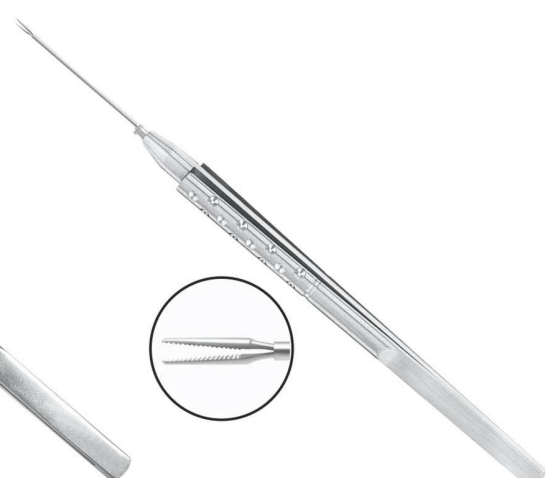

Item #: 7600
Name: Forceps Serrated Straight 20 gauge
Details: Horizontal opening, serrated jaws



Also Available in Titanium

Forceps



Item #: 7610
Name: Forceps End Gripping Straight 23 gauge
Details: Horizontal opening, end gripping jaws



Item #: 7620
Name: Forceps Side Gripping Vertical 23 gauge
Details: Vertical opening, smooth side gripping jaws



Item #: 7630
Name: Forceps Membrane Peeling Smooth 23 gauge
Details: Membrane peeling, smooth, 45 degree angled jaws



Item #: 7703
Name: Forceps Serrated Straight 23 gauge
Details: Horizontal opening, serrated jaws

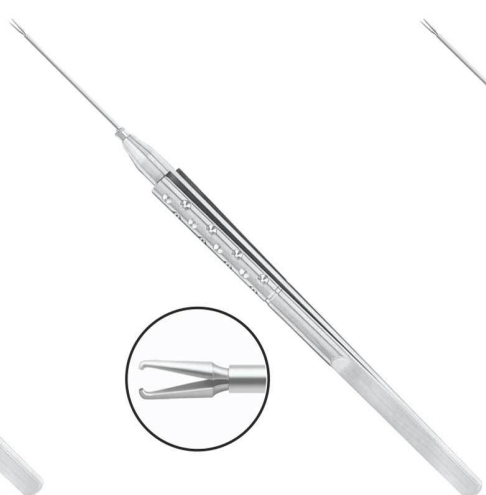

Item #: 7713
Name: Forceps End Gripping 23 gauge
Details: Horizontal opening, end gripping jaws

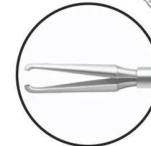

Item #: 7715
Name: Forceps End Gripping 25 gauge
Details: Horizontal opening, end gripping jaws



Item #: 7723
Name: Forceps Asymmetrical 23 gauge
Details: Asymmetrical jaws

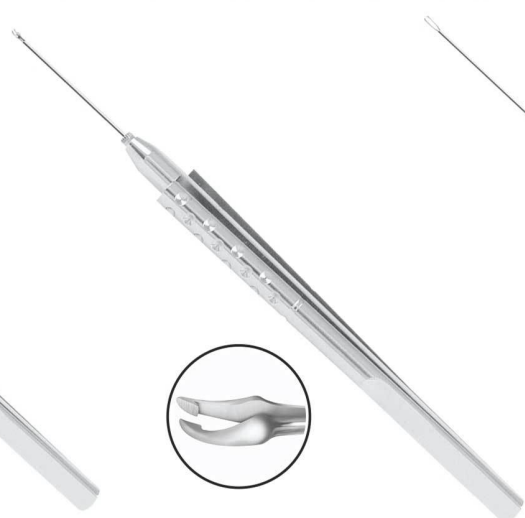

Item #: 7725
Name: Forceps Asymmetrical 25 gauge
Details: Asymmetrical jaws

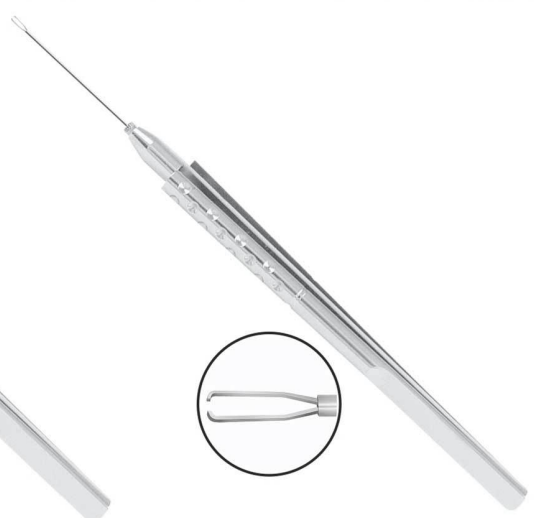

Item #: 7733
Name: Forceps ILM 23 gauge
Details: ILM

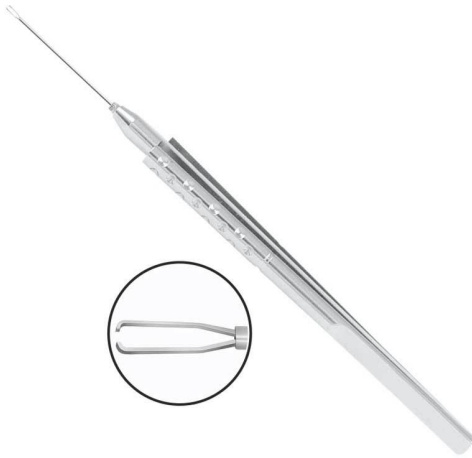

Item #: 7735
Name: Forceps ILM 25 gauge
Details: ILM



Item #: 8268
Name: Burratto Soft IOL Inserter
Details: Soft IOL inserting forceps with extra delicate, highly polished, convex jaws; for foldable acrylic and thin silicone IOLs



Item #: 9450
Name: Lambert Chalazion Forceps
Details: Round



Item #: 9500
Name: Hunt Chalazion Forceps
Details: Round



Item #: 9550
Name: Baird Chalazion Forceps
Details: Oval, 11x8mm inner diameter



Item #: 9600
Name: Francis Chalazion Forceps
Details: Oval, 14x11mm inner diameter



Item #: 9650
Name: Desmarres Chalazion Forceps
Details: Oval, 20x13mm inner diameter



Item #: 9850
Name: Serrefine Small Straight
Details: Serrated jaws, 1 1/2" (38mm) long

Also Available in Titanium



SURGICAL
ESSENCE

NEEDLE HOLDERS

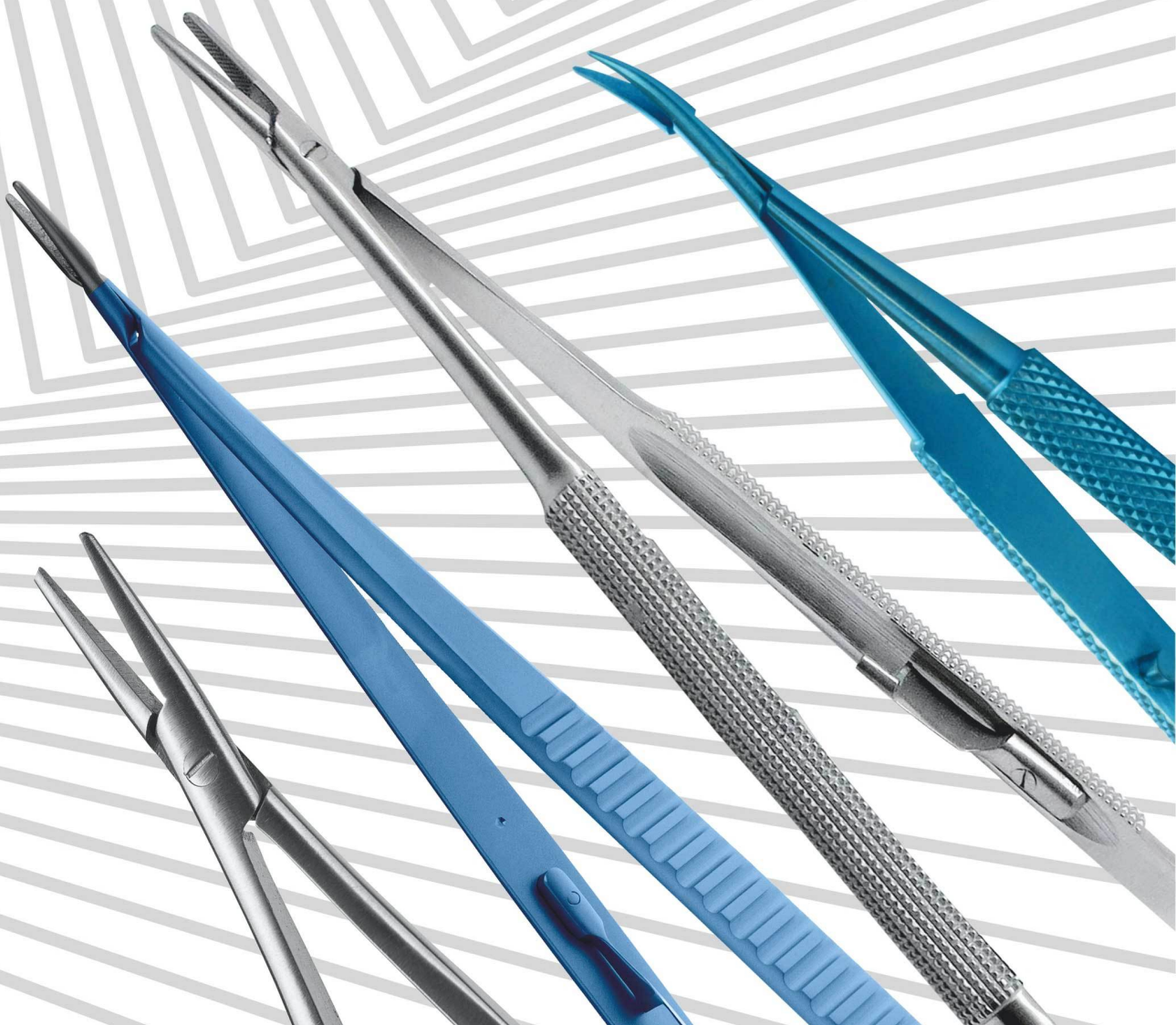



Item #: 02103

Name: McPherson Needle Holder, X Delicate, Curved W/Lock
Details: Extra delicate jaws
X-Delicate, Curved, W/Lock, Stainless Steel



Item #: 02104

Name: McPherson Needle Holder, X Delicate
Details: Extra delicate jaws
X-Delicate, Curved, W/O Lock, Stainless Steel



Item #: 02115

Name: Barraquer Needle Holder, Standard, Straight
Details: Standard jaws
Standard, Straight, W/O Lock, 13cm, Stainless Steel



Item #: 02117

Name: Barraquer Needle Holder, Delicate, Curved
Details: Delicate Jaws
Delicate, Curved, W/O Lock, 11.5cm, Stainless Steel



Item #: 02127

Name: Castroviejo Needle Holder, Delicate, Curved W/Lock
Details: Delicate Jaws
Delicate, Curved, W/Lock, Stainless Steel



Item #: 02128

Name: Castroviejo Needle Holder, Delicate
Details: Delicate Jaws
Delicate, Curved, W/O Lock, Stainless Steel



Item #: 02134

Name: Castroviejo Needle Holder, Curved
Details: Curved, W/O Lock, 5 1/2", Stainless Steel
Curved, W/O Lock, 5.5, Stainless Steel



Item #: 02135

Name: Castroviejo Needle Holder, Straight W/Lock
Details: Straight, with lock, 5 1/2", Stainless Steel
Straight, W/Lock, 5.5, Stainless Steel



Item #: 02156

Name: Anis Needle Holder, Straight, X Delicate
Details: Delicate Jaws
X-Delicate, Straight, W/O Lock, Stainless Steel

Also Available in Titanium

Needle Holders



Item #: 02158
Name: Anis Needle Holder, Curved, X Delicate
Details: Delicate Jaws
X-Delicate, Curved, W/O Lock, Stainless Steel



Item #: 1500
Name: Castroviejo Needle Holder Straight With Lock
Details: Delicate jaws



Item #: 1510
Name: Castroviejo Needle Holder Straight
Details: Delicate jaws



Item #: 1520
Name: Castroviejo Needle Holder Curved With Lock
Details: Delicate jaws



Item #: 1530
Name: Castroviejo Needle Holder Curved
Details: Delicate jaws



Item #: 3300
Name: Barraquer Needle Holder Curved With Lock
Details: Very delicate jaws



Item #: 3310
Name: Barraquer Needle Holder Curved
Details: Very delicate jaws



Item #: 3620
Name: Barraquer Needle Holder Curved With Lock
Details: Standard jaws



Item #: 3753
Name: Anis Needle Holder Curved
Details: Extra delicate jaws



- 

Item #: 07162
Name: Koch Nucleus Chopper
Details: Long blunted tip with rounded surfaces designed for safely splitting and dividing a very soft nucleus
- 

Item #: 14502
Name: Nagahara Phaco Chopper Right Hand Dominant
Details: Rounded, blunt tip with 0.9mm inferior wedge For use in left hand, Stainless Steel
- 

Item #: 14516L
Name: Seibel Nucleus Chopper Left Hand Dominant
Details: Blunt olive tip with 0.9mm inferior wedge For use in right hand, Stainless Steel
- 

Item #: 14529
Name: Rosen Phaco Splitter
Details: Stainless Steel
- 

Item #: 14530
Name: Nichamin I Quick Chopper Right Hand Dominant
Details: Ideal for vertical chopping For use in left hand, Stainless Steel
- 

Item #: 14566R
Name: Chang Chopper Right Hand Dominant Surgeon
Details: Chang MicroFinger For use in left hand, Stainless Steel
- 

Item #: 3660
Name: DLEK Corneal Dissector, Angled
Details: 12mm long x 3mm wide with semi-sharp spatulated tip
- 

Item #: 3661
Name: DLEK Corneal Dissector, Vaulted
Details: 12mm long x 3mm wide with semi-sharp spatulated tip
- 

Item #: 2327
Name: Phaco Chopper Ball Tip
Details: Ball tip with 0.7mm inferior wedge
- 

Item #: 2328
Name: Nagahara Phaco Chopper Short Handle
Details: Rounded, blunt tip with 0.9mm inferior wedge on 100mm handle
- 

Item #: 2329
Name: Nagahara Phaco Chopper
Details: Rounded, blunt tip with 0.9mm inferior wedge
- 

Item #: 2332
Name: Anis Phaco Chopper, Right
Details: Rounded, blunt, olive tip with offset inferior wedge

Also Available in Titanium



SURGICAL
ESSENCE

SPATULAS

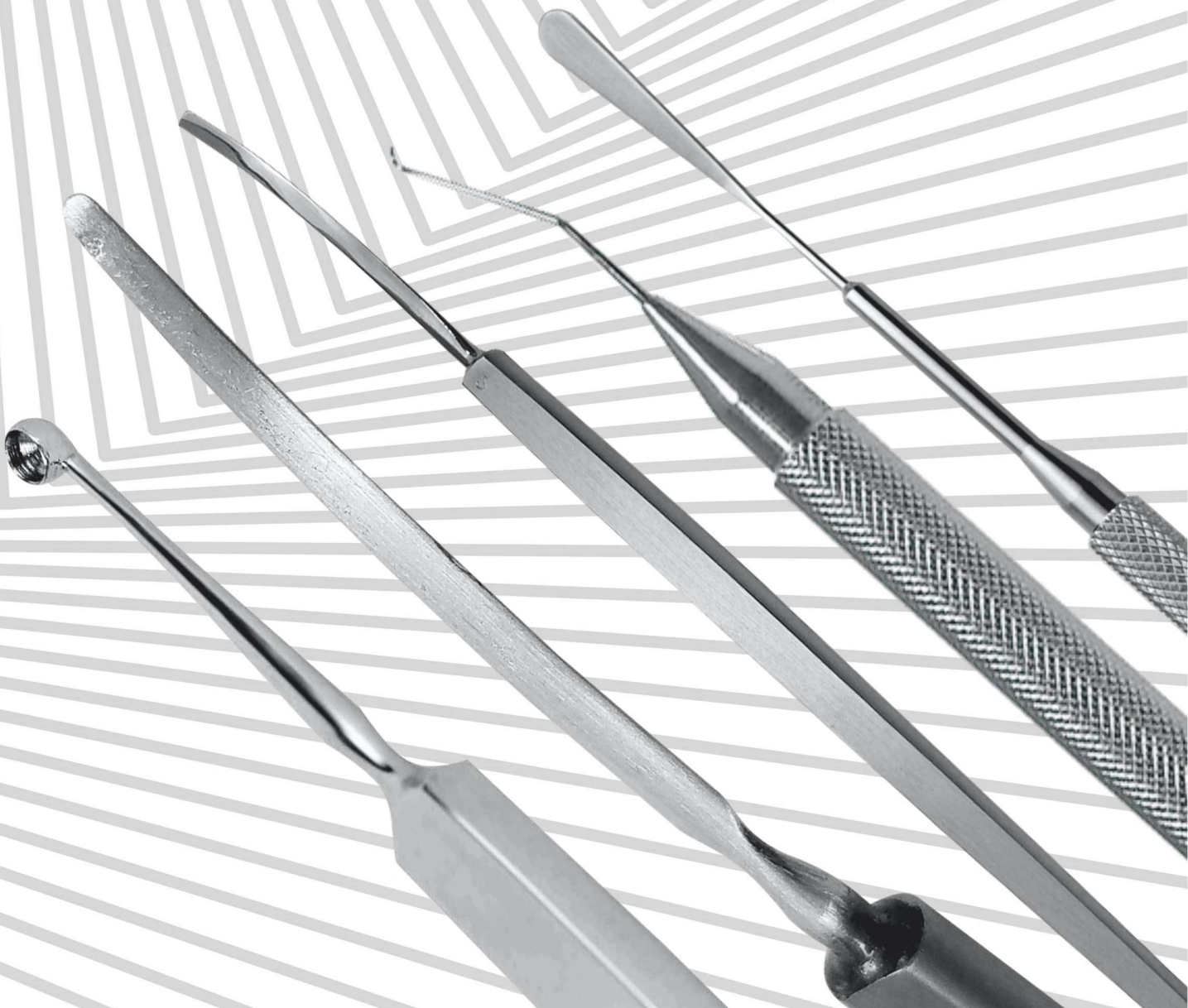

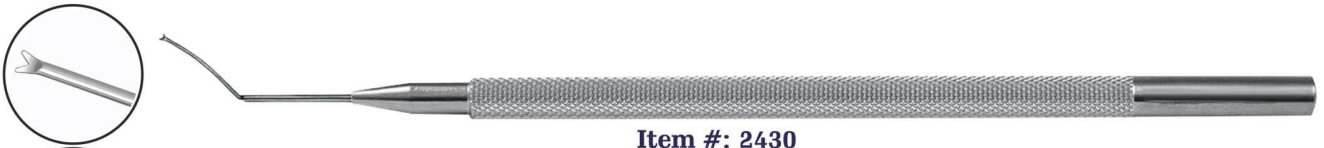

Item #: 2430

Name: Lippman Sideport Nucleus Spatula

Details: 0.5mm diameter round shaft with blunt forked tip

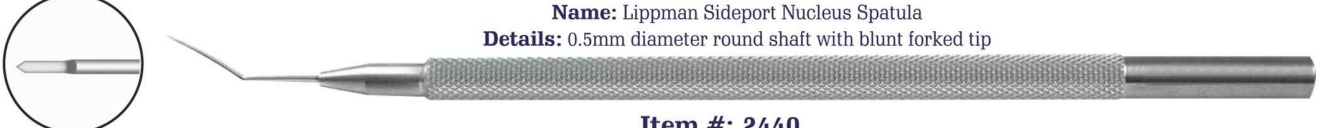

Item #: 2440

Name: Donnenfeld Femto Spatula

Details: 1mm long x 0.3mm wide flattened "spear-shaped" tip

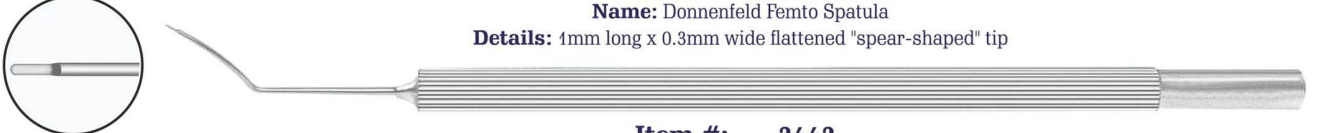

Item #: 2442

Name: Katena Femto Spatula, Blunt

Details: 1mm long x 0.3mm wide flattened "spear-shaped" tip



Item #: 2448

Name: Badawy Femto Splitter, Right

Details: Thin 80 degree offset paddle; can be used in all femto cases regardless of nucleus density

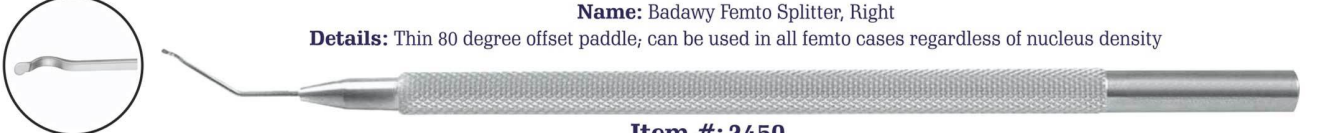

Item #: 2450

Name: Donnenfeld Femto Splitter Right

Details: Splitter with paracentral curve in shaft

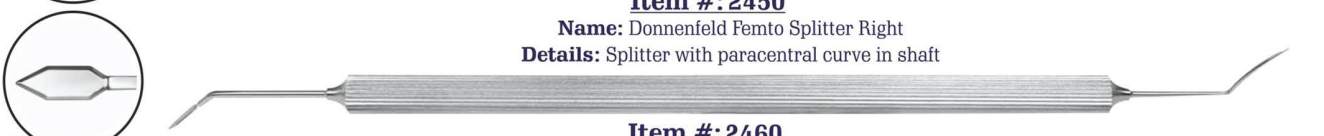

Item #: 2460

Name: Katena Femto Spatula, D-E

Details: Double-ended with blunt tips. 1mm flattened spatula on one end. 2mm keratome-shaped tip on other end.



Item #: 2500

Name: Girard Synecchia Spatula

Details: 0.5mm wide with semi-sharp tip

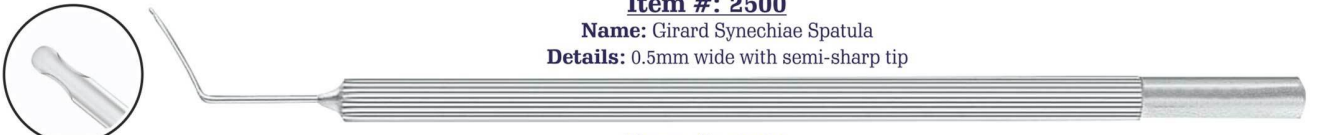

Item #: 2522

Name: Benedetto Intralase Spatula

Details: 10mm long, smoothly polished bi-convex spatula with beveled notches

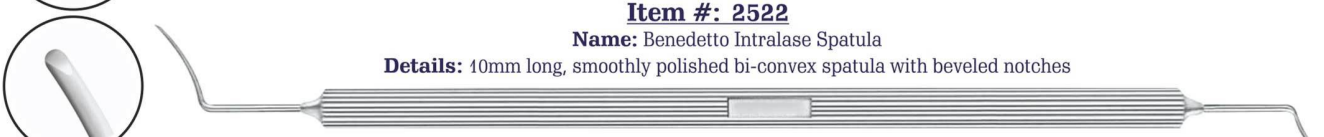

Item #: 2526

Name: Hersh Intralase Spatula Double Ended

Details: 10mm long spatula on one end and a 6mm long spatula on the opposite end. Each spatula has a 2mm beveled tip.



Item #: 2528

Name: Binder LASIK Flap Elevator

Details: 1mm wide x 12mm long with semi-sharp edges



Item #: 2530

Name: Fukasaku LASIK Spatula

Details: Rounded anterior and flat posterior surface with dissecting tip



Item #: 2532

Name: Guimaraes Corneal Spatula

Details: Gently curved, bi-convex semi sharp edges

Also Available in Titanium



Item #: 2538

Name: Intralase Flap Lifter Double Ended

Details: Combines a Sinskey Hook and a long, blunt hook



Item #: 2600

Name: Jaffe Lens Spatula 0.5mm

Details: Flat, 0.5mm wide



Item #: 3000

Name: Elschnig Cyclodialysis Spatula

Details: Flat, 1mm wide

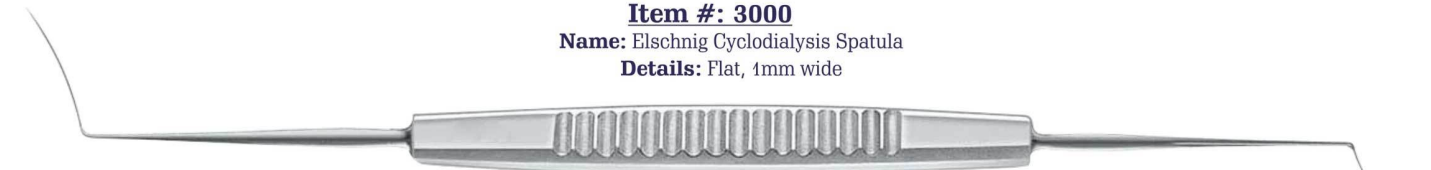

Item #: 3150

Name: Castroviejo Synechia Spatula

Details: 0.5mm wide with semi-sharp tips

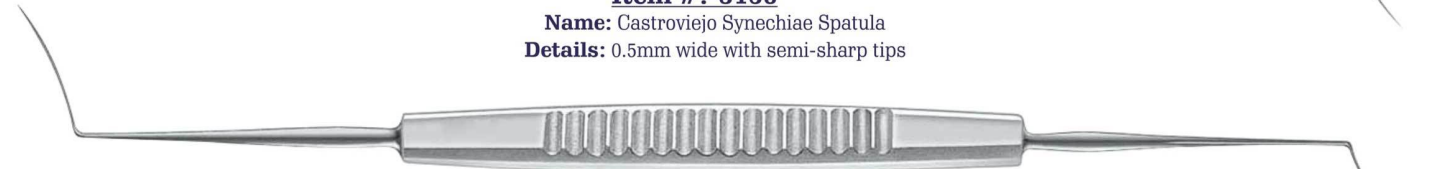

Item #: 3200

Name: Castroviejo Cyclodialysis Spatula 0.25mm

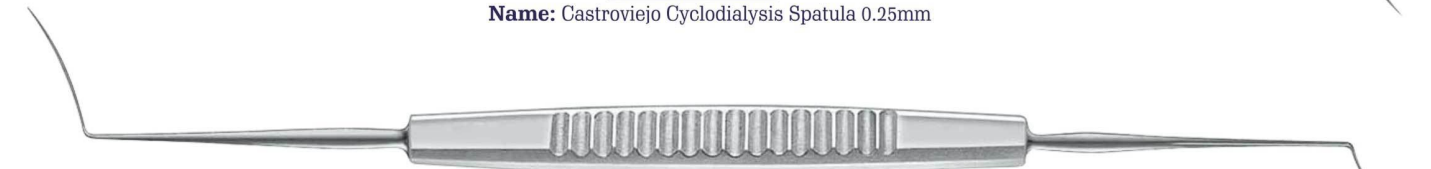

Item #: 3210

Name: Castroviejo Cyclodialysis Spatula 0.5mm



Item #: 3500

Name: Kimura Platinum Spatula



Item #: 4200

Name: Culler Lens Spoon

Details: Lens spoon, sterling silver



Item #: 4400

Name: Bunge Evisceration Spoon Small



Item #: 1000
Name: Meyerhoefer Curette #0
Details: Chalazion Curette



Item #: 1010
Name: Meyerhoefer Curette #1
Details: Chalazion Curette



Item #: 1020
Name: Meyerhoefer Curette #2t
Details: Chalazion Curette



Item #: 1030
Name: Meyerhoefer Curette #3
Details: Chalazion Curette



Item #: 1040
Name: Meyerhoefer Curette #4
Details: Chalazion Curette

Also Available in Titanium



Item #: 6154

Name: Katena Globe Fixation Ring

Details: Globe fixation ring with concentric grooves and 12mm inner diameter



Item #: 6160

Name: Gimbel Stabilization Ring

Details: Stabilization ring with swivel handle and 13mm diameter with blunt teeth on both sides



Item #: 6161

Name: Fine-Thornton Fixation Ring 13mm

Details: Swivel fixation ring with blunt teeth



Item #: 6162

Name: Fine-Thornton Fixation Ring Flat Teeth

Details: Swivel fixation ring with flat teeth, 13mm diameter



Item #: 6163

Name: Fine-Thornton Fixation Ring 16mm



Item #: 6165

Name: Thornton Fixation Ring

Details: Globe fixation ring with multiple blunt teeth, 16mm diameter ring



Item #: 6168

Name: Hofmann-Thornton Fixation Ring

Details: Globe fixation ring with swivel handle and multiple blunt teeth, 16mm diameter ring



Item #: 7737

Name: Dulaney LASIK Marker

Details: Corneal Marker for LASIK surgery for identification and realignment of the lamellar flap

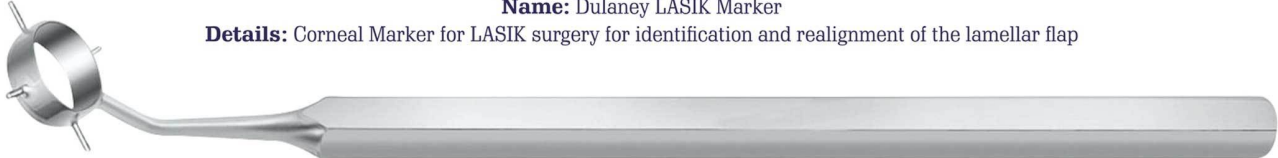

Item #: 7850

Name: Kellen CCC Marker 6.0mm

Details: Capsulorrhexis marker featuring 6mm diameter marking ring with 2.5mm extensions for alignment with the limbus



Item #: 7852

Name: Kellen CCC Marker 5.5mm

Details: Capsulorrhexis marker featuring 5.5mm diameter marking ring with four non-marking alignment pegs

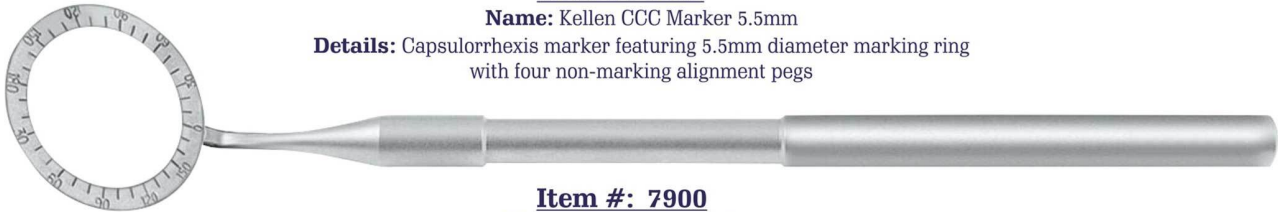

Item #: 7900

Name: Mendez Degree Gauge

Details: Degree gauge with 12mm inner diameter for accurate axial alignment on the cornea



Item #: 7904

Name: Henderson Degree Gauge

Details: Degree gauge featuring 11.7mm inner diameter with beveled face with marking in 5 degree increments and four notches on internal edge to align with cardinal positions.

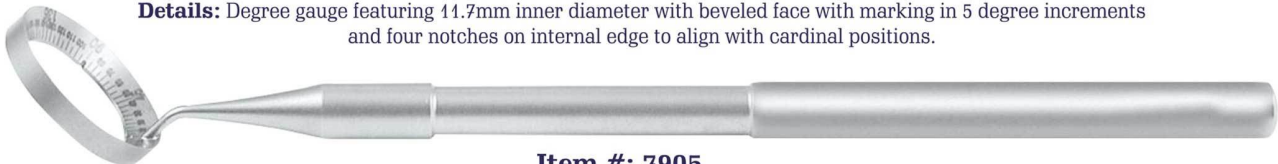

Item #: 7905

Name: Henderson Degree Gauge With Teeth

Details: Degree gauge featuring 11.7mm inner diameter with beveled face with marking in 5 degree increments and four notches on internal edge to align with cardinal positions; for use with K3-7912 or K3-7936



Item #: 7912

Name: Henderson Toric IOL Marker

Details: Toric IOL marker with two 2.5mm radial marks extending to 11mm; for use with K3-7904

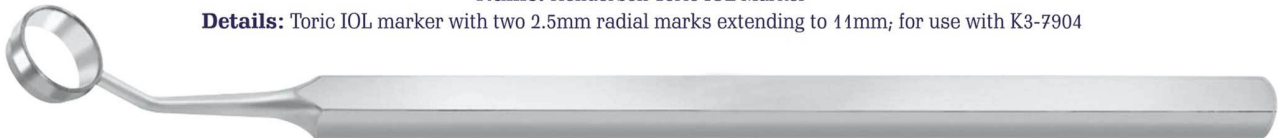

Item #: 8130

Name: Bores O-Z Marker 3.0mm

Details: Optic Zone Marker



Item #: 8131

Name: Bores O-Z Marker 3.25mm

Details: Optic Zone Marker









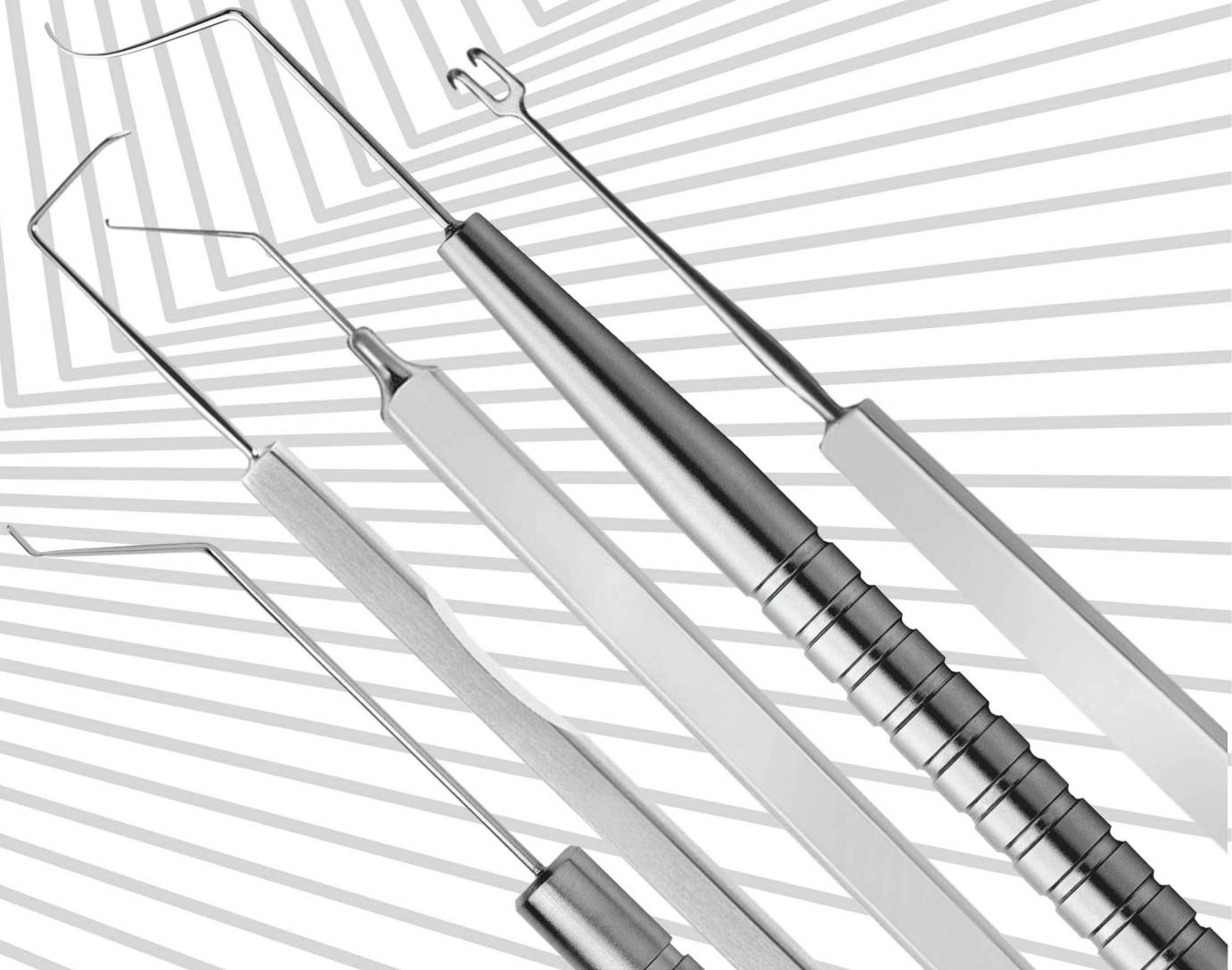











Also Available in Titanium



SURGICAL
ESSENCE

HOOKS



- | | |
|--|--|
|  |  |
| | Item #: 5002
Name: Reversed Sinskey Hook
Details: 0.2mm diameter blunt tip for scoring the recipient bed and to position the donor lamella |
|  |  |
| | Item #: 5160
Name: Jaffe Lens Hook Straight
Details: Lens manipulating hook featuring 0.15mm diameter blunt tip |
|  |  |
| | Item #: 5170
Name: Clayman-Jaffe Lens Hook Angled
Details: Lens manipulating hook featuring 0.15mm diameter blunt tip |
|  |  |
| | Item #: 5180
Name: Sinskey Lens Hook Straight
Details: Lens manipulating hook featuring 0.25mm diameter, straight, blunt tip |
|  |  |
| | Item #: 5192
Name: Sinskey Lens Hook Straight Round
Details: Round handle lens manipulating hook featuring 0.25mm diameter, straight, blunt tip |
|  |  |
| | Item #: 5193
Name: Sinskey Lens Hook Angled Round
Details: Round handle lens manipulating hook featuring 0.25mm diameter, angled, blunt tip |
|  |  |
| | Item #: 5220
Name: Sinskey II Lens Hook Straight
Details: Lens manipulating hook featuring 0.2mm diameter, angled, blunt tip |
|  |  |
| | Item #: 5230
Name: Sinskey II Lens Hook Angled
Details: Lens manipulating hook featuring 0.2mm diameter, straight, blunt tip |
|  |  |
| | Item #: 5232
Name: Sinskey II Lens Hook Straight Round
Details: Round handle lens manipulating hook featuring 0.2mm diameter, straight, blunt tip |
|  |  |
| | Item #: 5233
Name: Sinskey II Lens Hook Angled Round
Details: Round handle lens manipulating hook featuring 0.2mm diameter, angled, blunt tip |

Also Available in Titanium

Hooks



Item #: 5250

Name: Lewicky Lens Hook Angled

Details: Lens manipulating hook featuring a 0.15mm diameter, angled, blunt tip

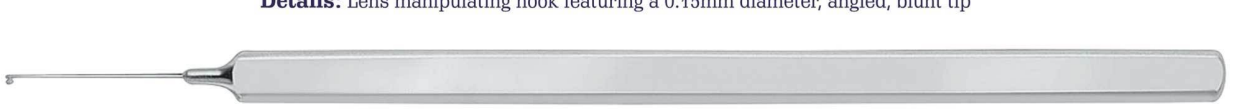

Item #: 5500

Name: Kuglen Iris Hook Push-Pull

Details: Push-pull model iris hook and lens manipulator

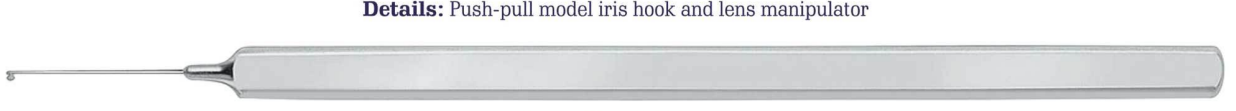
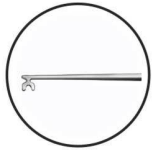

Item #: 5510

Name: Kuglen Iris Hook Clover Leaf

Details: Clover leaf model iris hook and lens manipulator



Item #: 5520

Name: Kuglen Iris Hook Angled

Details: Push-pull model iris hook and lens manipulator



Item #: 5522

Name: Kuglen Lens Manipulator Straight Round

Details: Push-pull model iris hook and lens manipulator on round handle



Item #: 5523

Name: Kuglen Lens Manipulator Angled Round

Details: Push-pull model iris hook and lens manipulator on round handle



Item #: 5528

Name: Osher Y-Hook Round Handle Straight

Details: Y-hook lens manipulator; straight, with guard



Item #: 5530

Name: Fenzl Lens Manipulator Straight

Details: Lens manipulating hook featuring 0.15mm diameter, straight tip

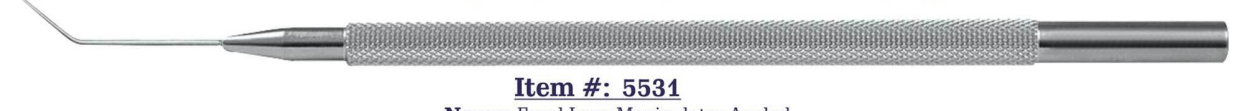

Item #: 5531

Name: Fenzl Lens Manipulator Angled

Details: Lens manipulating hook featuring 0.15mm diameter, angled tip



Item #: 5532

Name: Maltzman-Fenzl Lens Hook Straight

Details: Lens manipulating hook featuring 0.15mm diameter, straight tip



Item #: 5533

Name: Maltzman-Fenzl Lens Hook Angled

Details: Lens manipulating hook featuring 0.15mm diameter, angled tip



Item #: 5535

Name: Jaffe-Maltzman Lens Hook Angled

Details: Lens manipulating hook featuring 0.15mm diameter, angled tip



Item #: 6000

Name: Fixation Hook Double Sharp Small

Details: Sharp, double hooks



Item #: 6010

Name: Fixation Hook Double Sharp Large

Details: Sharp, double hooks



Item #: 6600

Name: Stevens Tenotomy Hook

Details: Blunt, small tenotomy hook



Item #: 6610

Name: Helveston Teaser Hook 6mm

Details: Extra delicate, blunt "teaser" hook



Item #: 6710

Name: Graefe Muscle Hook #1



Item #: 6720

Name: Graefe Muscle Hook #2



Item #: 6730

Name: Graefe Muscle Hook #3



Item #: 6760

Name: Helveston Finder Hook Large

Details: Extra delicate finder hook with lightly angled, cone-shaped tip

Also Available in Titanium



Item #: 4300

Name: SIMCOE I/A CANNULA CURVED

Details: 15mm long, 0.3mm diameter aspiration port, front opening irrigation port, 23 gauge thin wall, for aspiration through tubing hub and irrigation through luer-lock hub



Item #: 5804

Name: Aspiration Handpiece, 23 gauge, 0.3mm port

Details: With male connector and side port facing in to curve; magenta color

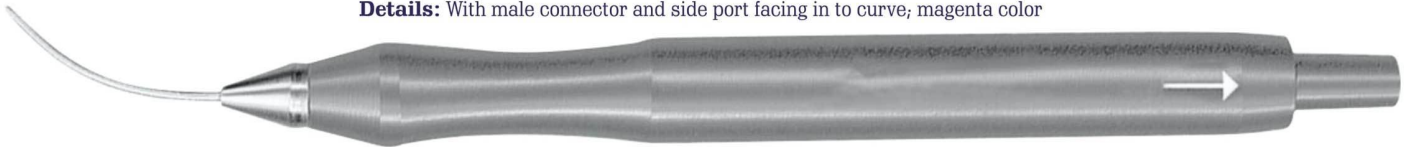

Item #: 5805

Name: Aspiration Hand Piece, 23 gauge, 0.3mm port, textured tip

Details: With male connector and side port facing in to curve; magenta color

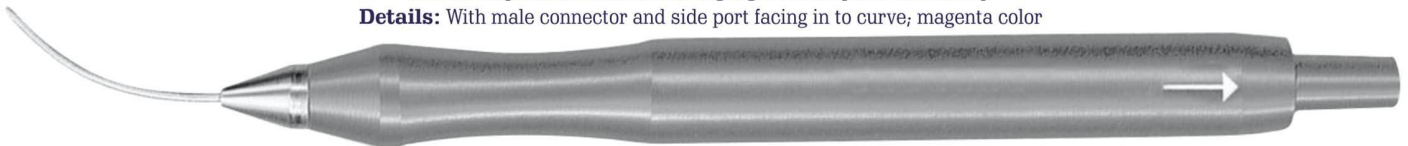

Item #: 5810

Name: Aspiration Handpiece, 21 gauge, 0.35mm port

Details: With male connector and side port facing in to curve; magenta color

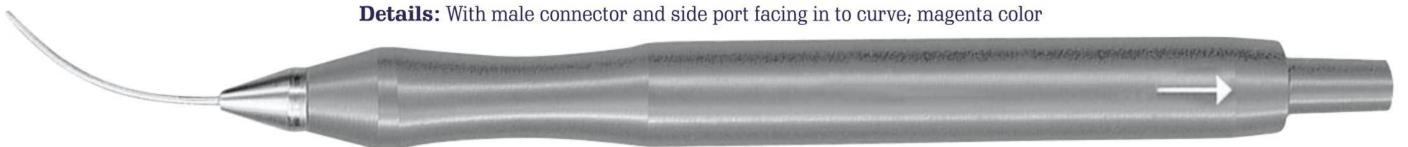

Item #: 5811

Name: Aspiration Hand Piece, 21 gauge, 0.35mm port, textured tip

Details: With male connector and side port facing in to curve; magenta color

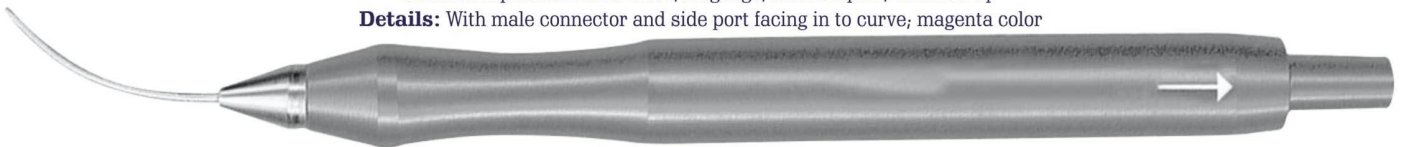

Item #: 5814

Name: Aspiration Handpiece, 21 gauge, 0.4mm port

Details: With male connector and side port facing in to curve; magenta color

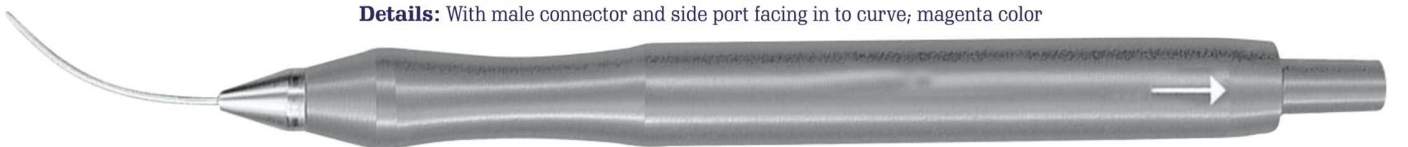

Item #: 5815

Name: Aspiration Hand Piece, 21 gauge, 0.4mm port, textured tip

Details: With male connector and side port facing in to curve; magenta color

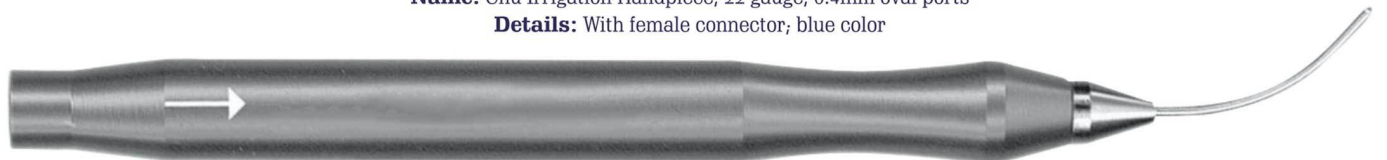
**Item #: 5816****Name:** Aspiration Handpiece, 22 gauge, 0.3mm oval port**Details:** With male connector and side port facing in to curve; magenta color**Item #: 5817****Name:** Aspiration Hand Piece, 22 gauge, 0.3mm oval port, textured tip**Details:** With male connector and side port facing in to curve; magenta color**Item #: 5818****Name:** Aspiration Handpiece, 21 gauge, 0.4mm oval port**Details:** With male connector and side port facing in to curve; magenta color**Item #: 5836****Name:** Irrigation Handpiece, 23 gauge, 0.3mm side ports**Details:** With female connector; blue color**Item #: 5838****Name:** Chu Irrigation Handpiece, 22 gauge, 0.4mm oval ports**Details:** With female connector; blue color**Item #: 5839****Name:** Chu Irrigation Handpiece, 24 gauge, 0.5mm oval ports**Details:** With female connector; blue color**Item #: 5840****Name:** Irrigation Handpiece, 24 gauge, 0.5mm ports**Details:** With female connector; blue color**Also Available in Titanium**



Item #: 1820

Name: LASEK Alcohol Well 8.5mm

Details: For retaining alcohol solution on the corneal epithelium

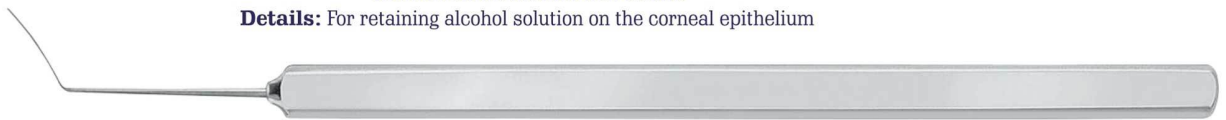

Item #: 1870

Name: DALK Corneal Dissector

Details: 12mm long, flattened, vaulted spatula with beveled tip

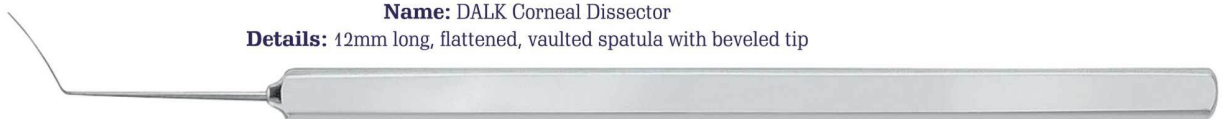

Item #: 1875

Name: Rosenwasser DALK Trisector

Details: Triangular shaft and spatulated tip

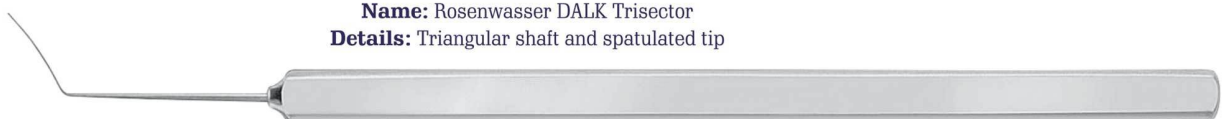

Item #: 1877

Name: Bonfadini DALK Spatula

Details: 1mm wide, 8mm long and flattened spatula with central groove for bisecting stroma



Item #: 2100

Name: Culler Iris Spatula 1.0mm



Item #: 2110

Name: Culler Iris Spatula 2.0mm



Item #: 2120

Name: Wheeler Spatula Double-Ended

Details: Double-ended, lightly curved

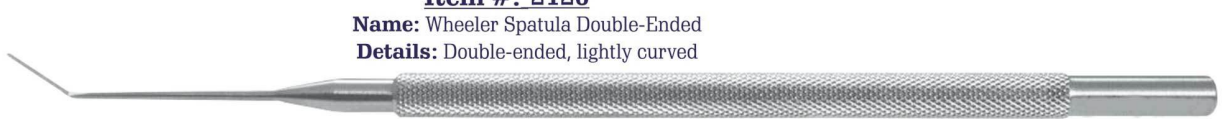

Item #: 2140

Name: Iris Spatula Angled 2 X 0.2mm

Details: Angled, 2mm wide x 8mm long x 0.2mm thick



Item #: 2150

Name: Johnson Spatula

Details: Round with blunt, pointed tip angled at 10mm

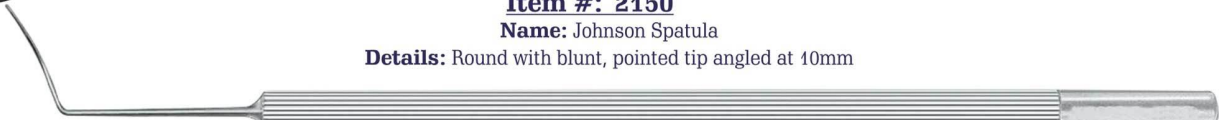

Item #: 2300

Name: Barraquer Iris Spatula 0.5mm

Details: Round, smooth



Item #: 2310

Name: Barraquer Iris Spatula 0.25mm

Details: Round, smooth



Item #: 2312

Name: Gimbel Nucleus Spatula 0.25mm

Details: Round, smooth and angled 30 degrees at 10mm from the tip (0.25mm diameter)



Item #: 2320

Name: Barraquer Ball Tip Spatula Double Ended

Details: Doubled-ended spatula featuring a 0.5mm Barraquer Iris Spatula & 90 degree ball tip manipulator



Item #: 2350

Name: Knolle Lens Nucleus Spatula

Details: Malleable stainless steel, flat; 0.5mm wide



Item #: 2354

Name: Koch Lens Nucleus Spatula

Details: Gently curved duckbill shaped tip



Item #: 2355

Name: Koch Nucleus Spatula With Notches

Details: Gently curved duckbill shaped tip

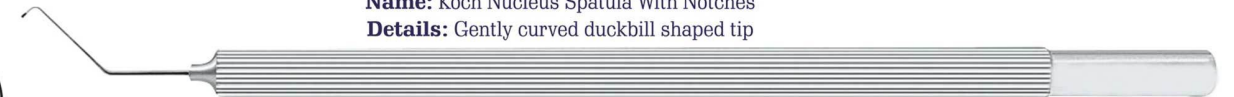

Item #: 2357

Name: Akahoshi Nucleus Sustainer

Details: Nucleus sustainer designed to provide counterpressure when used with the Akahoshi Phaco Prechopper (K5-7230)

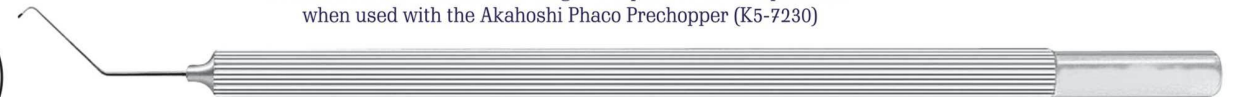

Item #: 2359

Name: Escaf Nucleus Sustainer

Details: Smooth ball tip, textured inferior surface



Item #: 2390

Name: Nagahara Lens Nucleus Spatula

Details: Flat inferior edge



Item #: 2400

Name: Bechert Nucleus Rotator 7mm

Details: Nucleus rotator with blunt forked tip



Item #: 2410

Name: Jaffe-Bechert Rotator 9mm

Details: Nucleus rotator with blunt forked tip



Item #: 2411

Name: Jaffe-Bechert Manipulator Angled Short Hndl

Details: Nucleus rotator with blunt forked tip

Also Available in Titanium

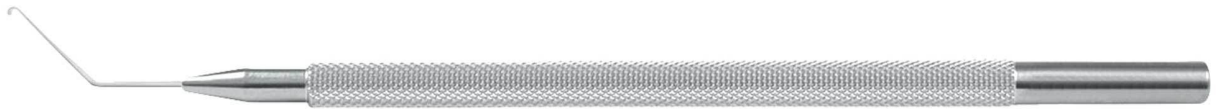

Item #: 2417

Name: Grayson Nucleus Manipulator
Details: Smoothly polished 1.1mm "tear-drop" shaped tip



Item #: 2418

Name: Drysdale Nucleus Manipulator
Details: Paddle shaped tip



Item #: 2419

Name: Drysdale Nucleus Manipulator/Polisher
Details: Paddle shaped tip



Item #: 2420

Name: Pisacano Nucleus Rotator Horizontal
Details: Nucleus rotator with flat disc shaped tip



Item #: 2421

Name: Pisacano Nucleus Rotator Vertical
Details: Nucleus rotator with flat disc shaped tip

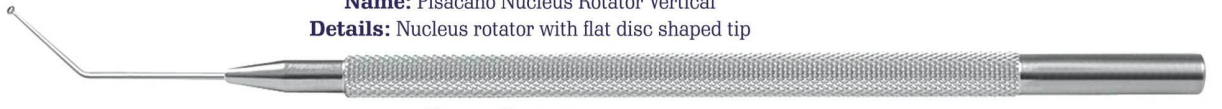

Item #: 2425

Name: Siepser Endocapsular Controller
Details: Endocapsular controller with trumpet shaped tip

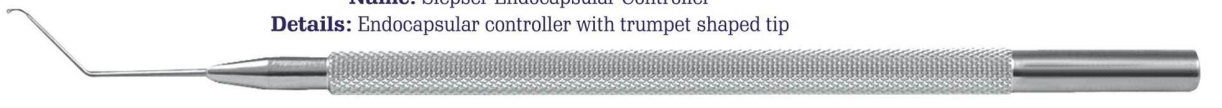

Item #: 2426

Name: Anis Ball Tip Manipulator Straight
Details: 0.5mm diameter ball tip

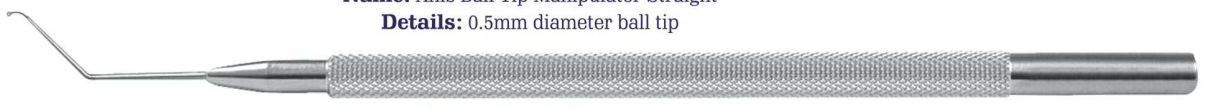

Item #: 2427

Name: Anis Ball Tip Manipulator Angled
Details: 0.5mm diameter ball tip

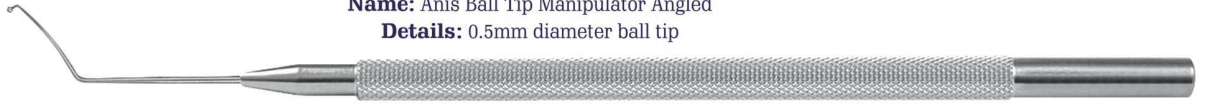

Item #: 2428

Name: Tennant Nucleus Manipulator Ball
Details: 0.6mm diameter ball tip

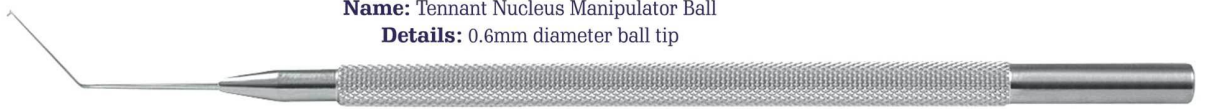

Item #: 2690

Name: Lester IOL Manipulator Angled
Details: Ideal for multi-directional manipulation



Item #: 4000

Name: Lewis Lens Loop Small



SURGICAL
ESSENCE

Lacrimal INSTRUMENTS

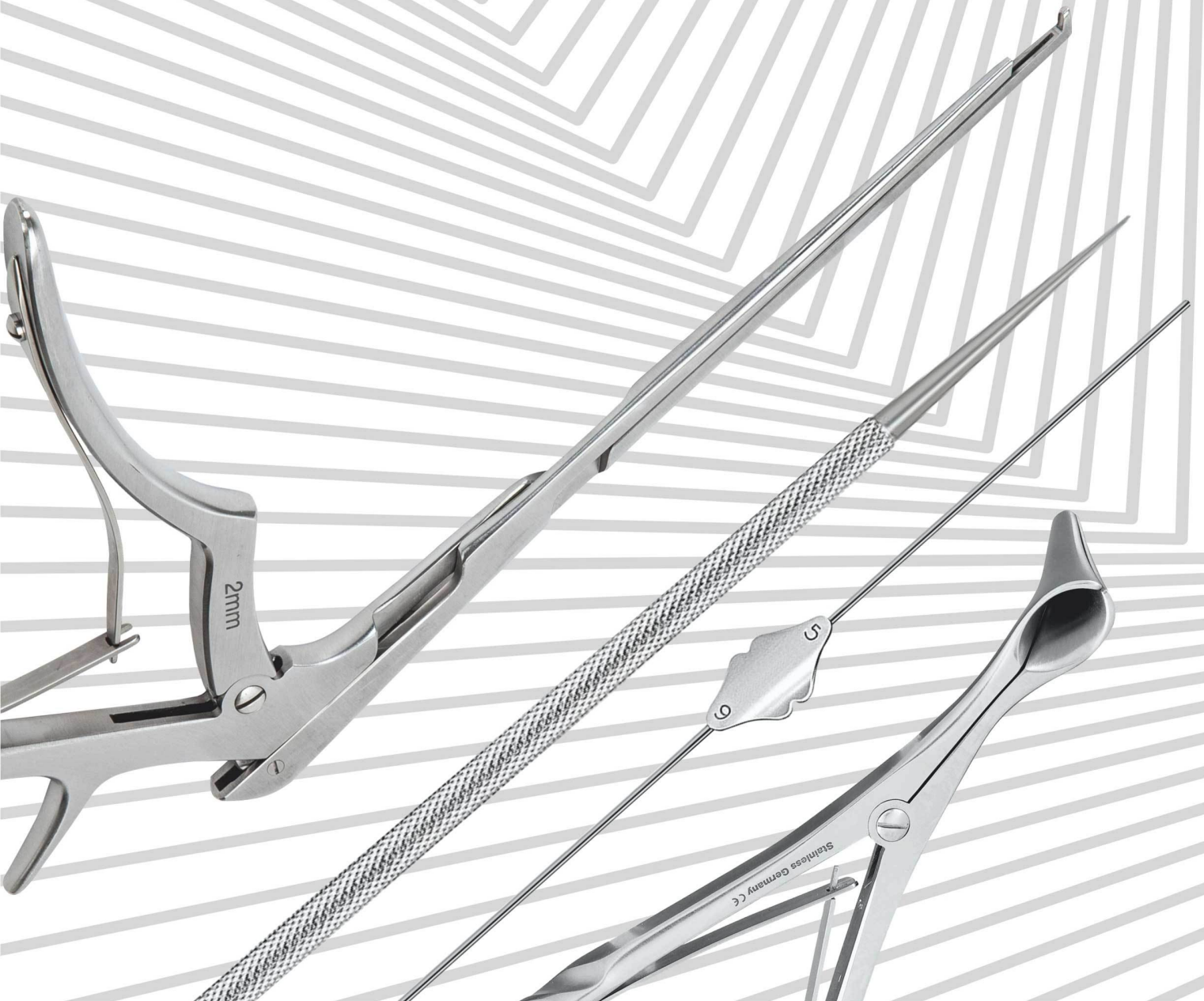



Item #: 09110

Name: Castroviejo Lacrimal Dilator, D-E

Details: Double-end, fine and medium taper Double Ended, Stainless Steel

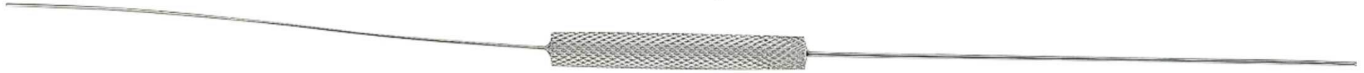

Item #: 09124

Name: Bowman Lacrimal Probe Size 1-2

Details: Malleable stainless steel 1-2, Stainless Steel



Item #: 1800

Name: Kerrison Rongeur Size 0

Details: Bone nibbling rongeur, 9mm opening

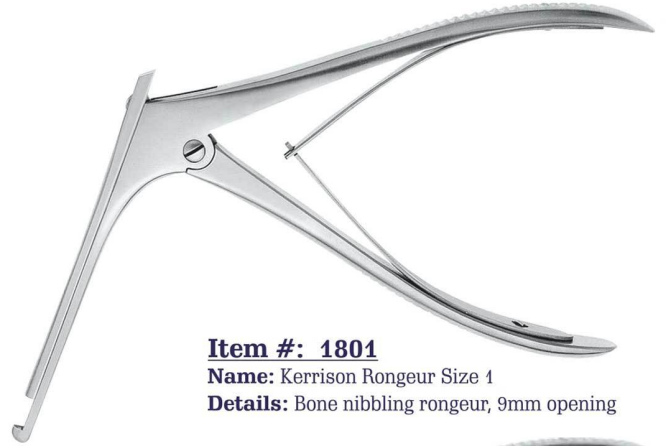

Item #: 1801

Name: Kerrison Rongeur Size 1

Details: Bone nibbling rongeur, 9mm opening



Item #: 1802

Name: Kerrison Rongeur Size 2

Details: Bone nibbling rongeur, 9mm opening



Item #: 1803

Name: Kerrison Rongeur Size 3

Details: Bone nibbling rongeur, 9mm opening



Item #: 1810

Name: Beyer Rongeur

Details: Single action



Item #: 1821

Name: Nasal Speculum Child



Item #: 1830

Name: Freer Periosteal Elevator

Details: One end blunt, other end semi-sharp; 4.5mm wide blades

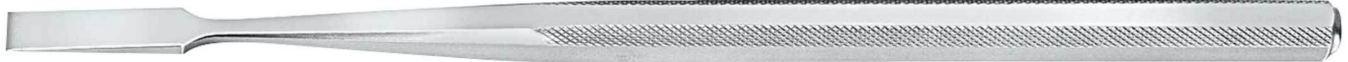

Item #: 1840

Name: West Lacrimal Chisel

Details: Straight



Item #: 2000

Name: Infant Lacrimal Dilator

Details: Very fine blunt tip



Item #: 2110

Name: Wilder Lacrimal Dilator #1



Item #: 2120

Name: Wilder Lacrimal Dilator #2



Item #: 2130

Name: Wilder Lacrimal Dilator #3



Item #: 2300

Name: Castroviejo Lacrimal Dilator

Details: Double-end, fine and medium taper

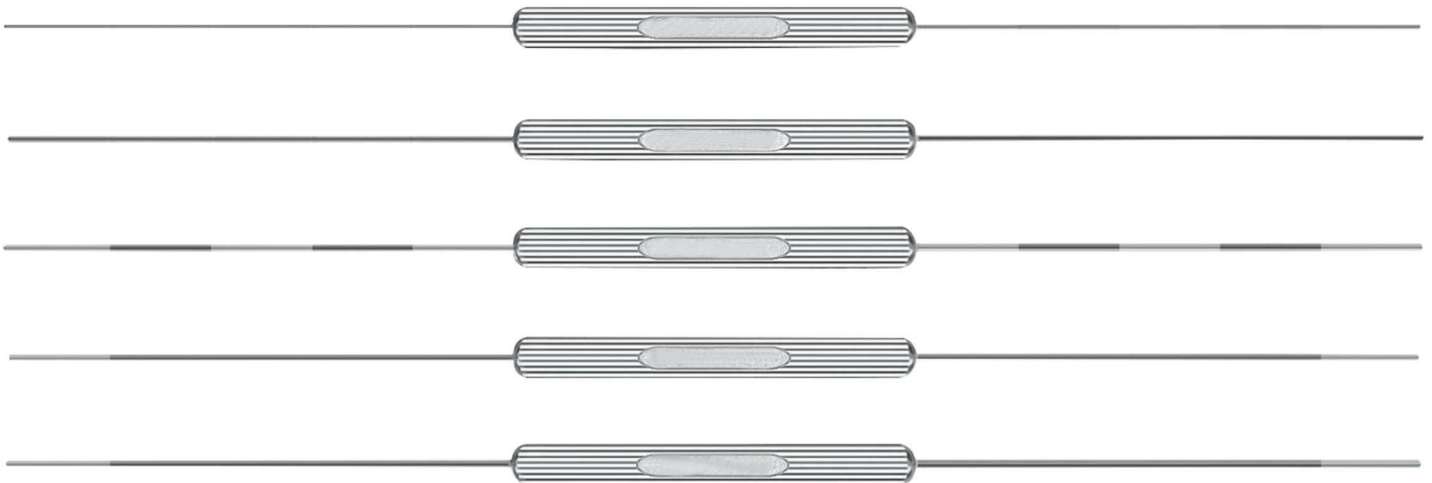

Item #: 2480

Name: Miyake Lacrimal Probe Set Of 5

Details: Rounded, knurled handle, 140mm long

Also Available in Titanium



Item #: 2332
Name: Anis Phaco Chopper, Right
Details: Rounded, blunt, olive tip with offset inferior wedge



Item #: 2332
Name: Anis Phaco Chopper, Right
Details: Rounded, blunt, olive tip with offset inferior wedge



Item #: 2332
Name: Anis Phaco Chopper, Right
Details: Rounded, blunt, olive tip with offset inferior wedge



Item #: 2332
Name: Anis Phaco Chopper, Right
Details: Rounded, blunt, olive tip with offset inferior wedge



Item #: 2332
Name: Anis Phaco Chopper, Right
Details: Rounded, blunt, olive tip with offset inferior wedge

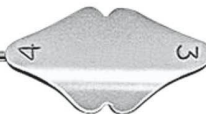

Item #: 2332
Name: Anis Phaco Chopper, Right
Details: Rounded, blunt, olive tip with offset inferior wedge



Item #: 2481

Name: Miyake Lacrimal Probe .45 And .5mm

Details: Rounded, knurled handle, 140mm long



Item #: 2483

Name: Miyake Lacrimal Probe .55 And .6mm

Details: Rounded, knurled handle, 140mm long



Item #: 2485

Name: Miyake Lacrimal Probe .65 And .7mm

Details: Rounded, knurled handle, 140mm long, marked in 10mm increments



Item #: 2487

Name: Miyake Lacrimal Probe .75 And .8mm

Details: Rounded, knurled handle, 140mm long, single mark at 10mm from tips

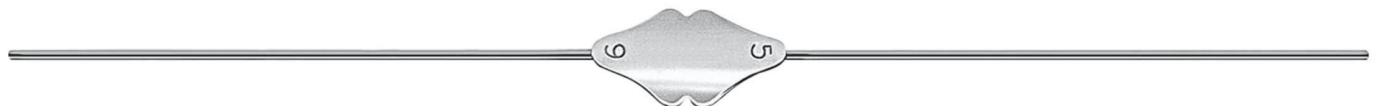

Item #: 2489

Name: Miyake Lacrimal Probe .85 And .9mm

Details: Rounded, knurled handle, 140mm long, single mark at 10mm from tips

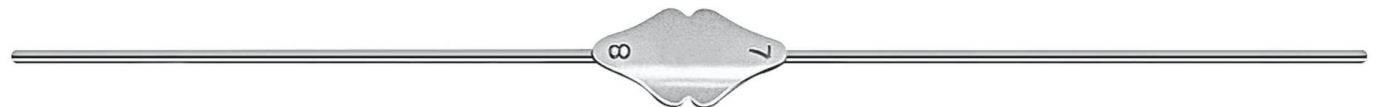

Item #: 2560

Name: Bowman Lacrimal Probe #7-8

Details: Malleable stainless steel



Item #: 2900

Name: Pigtail Probe

Details: With suture holes

Also Available in Titanium



SURGICAL
ESSENCE

CANNULAS

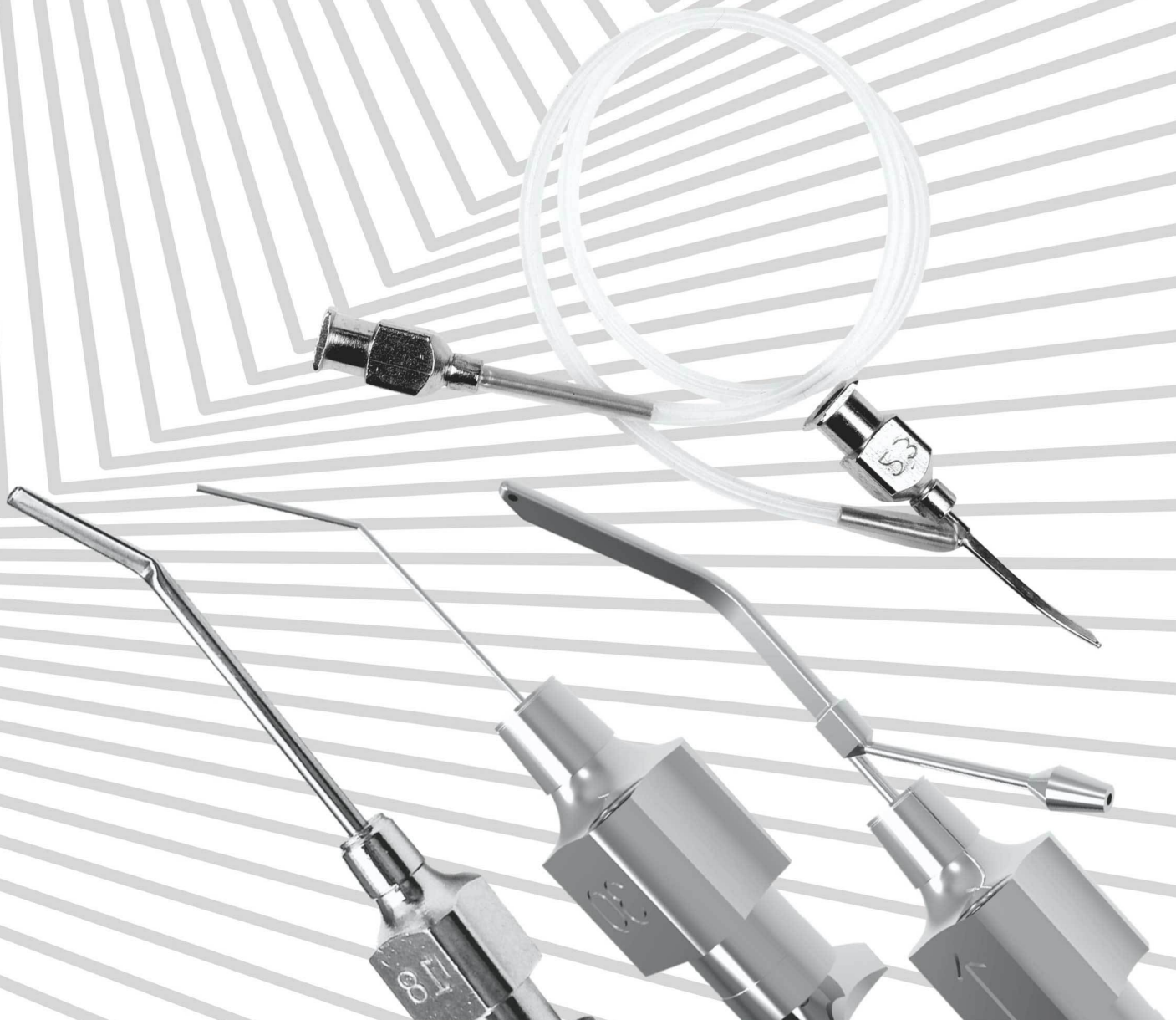

Item #: 7035
Name: Bishop Harmon Cannula 19g
Details: 19g, 7mm, Stainless Steel



Item #: 7045
Name: Troutman Alpha Chymotrypsin Cannula 25g
Details: Delicate, 25 gauge
25g, 28mm, Stainless Steel



Item #: 7060
Name: Simcoe Double Barreled IA Reverse Cannula 23g Thin Wall
Details: 15mm long, 0.3mm diameter aspiration port, front opening irrigation port,
23 gauge thin wall; for aspiration through luer-lock hub and irrigation through tubing hub
23g, Thin Wall, Reverse, Stainless Steel



Item #: 7078
Name: Masket Sub Tenon Anesthesia Cannula 19g
Details: 19 gauge, gently curved smooth tip; for "pinpoint" placement of
local anesthesia solution into sub-tenon's space
19g, Stainless Steel



Item #: 7080
Name: Atkinson Retrobulbar Cannula 23g
Details: 23 gauge, gently curved smooth tip; for "pinpoint" placement of local
anesthesia solution into sub-tenon's space
23g, 1.5, Stainless Steel



Item #: 7091-2
Name: Lessner Capsule Scraper 27ga
Details: 3mm angled tip, front opening, finely textured
27g, 3mm, Sandblasted, Stainless Steel



Item #: 7093
Name: Simcoe Capsule Scraper Cannula 23g 13mm Length
Details: 23 gauge, gently curved, finely textured
23g, 13mm, Stainless Steel



Item #: 7118
Name: Lacrimal Cannula 19g Straight
Details: Malleable tip, 19 gauge



Item #: 7042
Name: Simcoe Cortex Extractor 23g, 0.3mm Port
Details: 0.3mm side port, 21mm long, 23 gauge 23g, 21mm, Stainless Steel



Item #: 7053
Name: Randolph Cyclodialysis Cannula 21g Front Opening
Details: Formed flat tip, angled at 13mm
21g, Front Opening, Stainless Steel



Item #: 7067
Name: Binkhorst McIntyre 26g Cannula 18mm Straight
Details: "J" shaped, smooth blunt tip, end opening, 26 gauge
26g, 18mm, Straight, Stainless Steel



Item #: 7079
Name: Rhein Open Sub Tenon Anesthesia Cannula 19g
Details: 19 gauge, gently curved smooth tip; for "pinpoint" placement of
local anesthesia solution into sub-tenon's space
19g, Stainless Steel



Item #: 7090
Name: Kratz Capsule Scraper Cannula 23g
Details: 1mm angled tip, front opening, finely textured
23g, 1mm, Sandblasted, Stainless Steel



Item #: 7091
Name: Knolle Capsule Scraper Cannula 23g
Details: 2mm angled tip, front opening, finely textured
23g, 2mm, Sandblasted, Stainless Steel



Item #: 7103
Name: Knolle Anterior Chamber Cannula 30g Angled 2mm Tip 20mm
Details: 2mm angled tip, front opening, smooth blunt tip
30g, 2mm, Stainless Steel

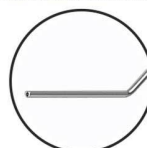

Item #: 7128
Name: Anterior Chamber Cannula 26g
Details: 26 gauge, angled 26g, 12mm, Angled, Stainless Steel



Cannulas



Item #: 7133A
Name: Hydrodissection Cannula J Shaped 27g Flattened Angled Shaft
Details: "J" shaped, flat blunt tip, end opening, 27 gauge 27g, Angled, Stainless Steel



Item #: 7142
Name: Khouri Hydrodissection Cannula 23g Right
Details: Spoon shaped tip, 23g 23g, Right, Stainless Steel



Item #: 7206
Name: Utrata 27g Hydrodissection J Cannula
Details: "J" shaped, flat blunt tip, end opening, 27 gauge 27g, Stainless Steel



Item #: 8011
Name: McIntyre III 27g Hydrodissection Cannula
Details: 27g, Stainless Steel



Item #: 8014
Name: Slade LASIK 26g Formed Irrigation Cannula
Details: Open end for easy insertion under the flap 26g, Stainless Steel



Item #: 8015
Name: Pettigrove Irrigating LASIK Cannula
Details: Open end for easy insertion under the flap, 6 ports to assist repositioning the flap Stainless Steel



Item #: 8018
Name: Banaji LASIK Irrigation Cannula 25g
Details: Bullet shaped tip, 3 ports for multi-directional irrigation, 25 gauge



Item #: 8019
Name: Bansal LASIK Irrigation Cannula 25g
Details: Bullet shaped tip, 3 ports for multi-directional irrigation, 25 gauge



Item #: 8022
Name: Guell LASIK Irrigation Cannula 25g
Details: Bullet shaped tip, 6 ports for multi-directional irrigation, 25 gauge



Item #: 8024
Name: Manche LASIK Irrigation Cannula 25g
Details: Closed end with two ports to irrigate the flap 25g, Stainless Steel



Item #: 8029L
Name: Seibel LASIK Flap Irrigator & Squeegee Cannula Left Ports
Details: Bullet shaped tip, 6 ports for one directional irrigation Left, Stainless Steel



Item #: 8030
Name: Huang LASIK Cannula 2 Ports 23g
Details: Bullet shaped tip, 2 ports for multi-directional irrigation, 23 gauge 23g, Stainless Steel



Item #: 8051
Name: Anis Cortex Aspiration Cannula, Angled, 23g
Details: 4mm sideport for aspiration, angled 23g, Thin Wall, Stainless Steel



Item #: 8053
Name: Rivero-Kurz DMEK Cannula 25g
Details: Bullet shaped tip, 6 ports for multi-directional irrigation, 25 gauge, Used to unfurl the donor tissue 25g, 9mm, Stainless Steel

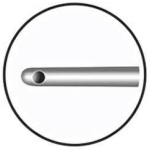

Item #: 3100
Name: West Irrigating Cannula
Details: Blunt tip, 0.3mm side opening, 23 gauge

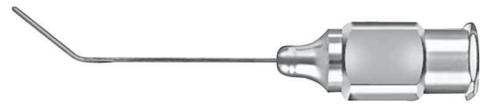
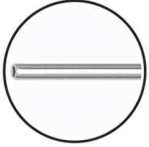

Item #: 3502
Name: Air Injection Cannula 30 gauge, 7mm angled
Details: Angled at 7mm

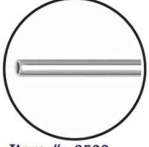

Item #: 3522
Name: Air Injection Cannula 27 gauge, 7mm angled
Details: Angled at 7mm

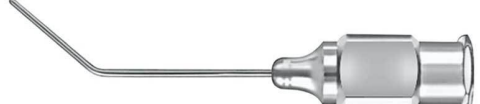
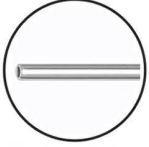

Item #: 3552
Name: Viscoelastic Aspirating Cannula 19 gauge
Details: Angled at 10mm



Item #: 3595
Name: Rosenwasser DALK Cannula
Details: Flattened, "cobra-shaped" tip, 0.2mm posterior port, 27 gauge



Item #: 3620
Name: Randolph Cyclodialysis Cannula Standard
Details: Formed flat tip, angled at 13mm

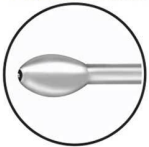

Item #: 3805
Name: LASEK Alcohol Cannula
Details: Delicate olive shaped tip, 25 gauge



Item #: 4005
Name: Stevens Sub-Tenon Cannula
Details: 19 gauge, gently curved flat tip; for atraumatic entry into sub-tenon's space to inject local anesthetic

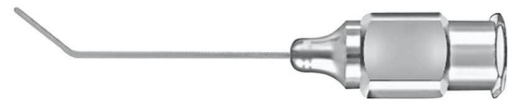
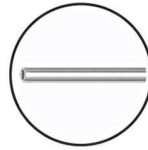

Item #: 3500
Name: Air Injection Cannula 30 gauge, 5mm angled
Details: Angled at 5mm

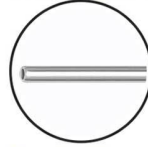

Item #: 3520
Name: Air Injection Cannula 27 gauge, 5mm angled
Details: Angled at 5mm

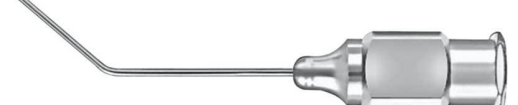
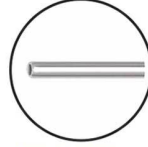

Item #: 3550
Name: Viscoelastic Aspirating Cannula 22 gauge
Details: Angled at 10mm



Item #: 3590
Name: DALK Air Injection Cannula
Details: Flattened, vaulted, 0.2mm posterior port near tip, 27 gauge



Item #: 3600
Name: Randolph Cyclodialysis Cannula
Details: Formed flat tip, angled at 13mm

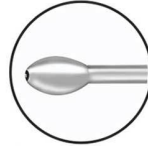

Item #: 3800
Name: Troutman Cannula Olive Tip
Details: Delicate, 25 gauge

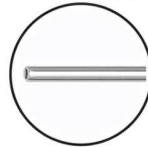

Item #: 4002
Name: Fukasaku Anesthesia Cannula
Details: 24 gauge, gently curved smooth tip; for "pinpoint" placement of local anesthesia solution into sub-tenon's space

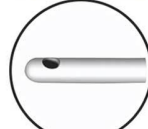

Item #: 4008
Name: Corbin Sub-Tenon Cannula
Details: 23 gauge, smooth rounded tip, 0.3mm side port

Cannulas



Item #: 4010
Name: Gross Sub-Tenons Cannula
Details: 21 gauge, gently curved flat burnished tip, front opening



Item #: 4304
Name: Gess Irrigating-Aspirating Cannula Right
Details: U-shaped aspiration tip, end opening port, 23 gauge; supplied with silicone tubing and adaptor, for aspiration through tubing hub and irrigation through luer-lock hub



Item #: 4305
Name: Gess Irrigating-Aspirating Cannula Left
Details: U-shaped aspiration tip, end opening port, 23 gauge; supplied with silicone tubing and adaptor, for aspiration through tubing hub and irrigation through luer-lock hub



Item #: 4309
Name: Simcoe Irrigating-Aspirating Cannula Left
Details: U-Shaped, 0.3mm anterior aspiration port, 23 gauge, supplied with silicone tubing and adaptor, for aspiration through tubing hub and irrigation through luer-lock hub



Item #: 4920
Name: Jensen Capsule Polisher 25 gauge, half-textured
Details: Carbide impregnated on posterior surface of olive tip, front opening, for polishing the anterior and/or posterior capsule



Item #: 4921
Name: Jensen Polisher 25 gauge, fully-textured
Details: Carbide impregnated all around olive tip, front opening, for polishing the anterior and/or posterior capsule



Item #: 4933
Name: Lu Capsule Polisher
Details: Flattened olive shaped tip, carbide impregnated on the posterior surface, front opening, 23 gauge



Item #: 4300
Name: SIMCOE I/A CANNULA CURVED
Details: 15mm long, 0.3mm diameter aspiration port, front opening irrigation port, 23 gauge thin wall, for aspiration through tubing hub and irrigation through luer-lock hub



Item #: 4302
Name: Reversed Simcoe Irrigating-Aspirating Cannula
Details: 15mm long, 0.3mm diameter aspiration port, front opening irrigation port, 23 gauge thin wall, for aspiration through luer-lock hub and irrigation through tubing hub



Item #: 4308
Name: Simcoe Irrigating-Aspirating Cannula Right
Details: U-Shaped, 0.3mm anterior aspiration port, 23 gauge, supplied with silicone tubing and adaptor, for aspiration through tubing hub and irrigation through luer-lock hub



Item #: 4450
Name: Gills Irrigating-Aspirating Cannula
Details: Front openings with irrigating port recessed 0.5mm from tip, angled 23 gauge thin wall, supplied with silicone tubing and adaptor



Item #: 4320
Name: Strauss MSICS Simcoe Irrigation-Aspiration Cannula
Details: 23 gauge, 0.3mm port, elongated and gently curved with 15 degree angled tip, for "through the tunnel" I/A during manual small incision cataract surgery (MSICS)



Item #: 4931
Name: Jensen Polisher 23 gauge, fully-textured
Details: Carbide impregnated all around olive tip, front opening, for polishing the anterior and/or posterior capsule

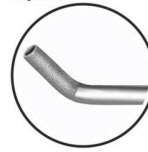

Item #: 4940
Name: Knolle Capsule Polisher 30 gauge
Details: 2mm angled tip, front opening, finely textured



Item #: 5052
Name: Bishop-Harmon Irrigating Cannula 21 gauge



Item #: 5054
Name: Hydrodissection Cannula
Details: Angled at 8mm, flat tip, 25 gauge



Item #: 5095
Name: Irrigating Cannula 23 gauge
Details: 0.4mm dual side ports



Item #: 5108
Name: Fukasaku LASIK Cannula
Details: Low profile tip, end opening, 23 gauge



Item #: 5120
Name: McIntyre Anterior Chamber Cannula 23 gauge, Straight
Details: Smooth blunt tip



Item #: 5174
Name: Gimbel Cortex Aspirating Cannula
Details: End opening, 30 gauge

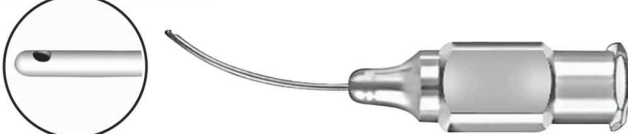

Item #: 5230
Name: Simcoe Cortex Extractor Smooth, 21mm
Details: 0.3mm side port, 21mm long, 23 gauge



Item #: 5240
Name: Anis Cortex Aspirating Cannula Straight
Details: 0.4mm side port, finely textured tip, 23 gauge thin wall



Item #: 5053
Name: Peters Hydrodissection Cannula
Details: 25 gauge, 3mm long, vertically flattened tip



Item #: 5096
Name: Irrigating Cannula 21 gauge
Details: 0.5mm dual side ports



Item #: 5097
Name: Irrigating Cannula 22 gauge
Details: 0.4mm oval dual side ports



Item #: 5117
Name: Buratto LASIK Irrigating Cannula 25 gauge
Details: One front and two side ports; designed for equal flow in three directions

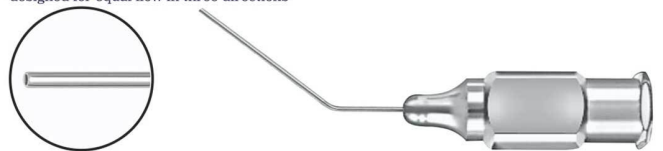

Item #: 5150
Name: McIntyre Anterior Chamber Cannula 26 gauge, Angled
Details: Smooth blunt tip

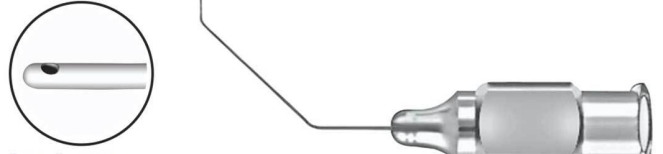

Item #: 5220
Name: Simcoe Cortex Extractor Smooth, 13mm
Details: 0.3mm side port, 13mm long, 23 gauge



Item #: 5235
Name: Nevyas-Wallace Cortex Liberating Cannula
Details: curved, end port with sandblasted tip, 27 gauge; to aid in the gentle removal of cortex



Item #: 5360
Name: Gills Aspirating Cannula 5mm
Details: Smooth blunt tip, end opening, angled, 25 gauge

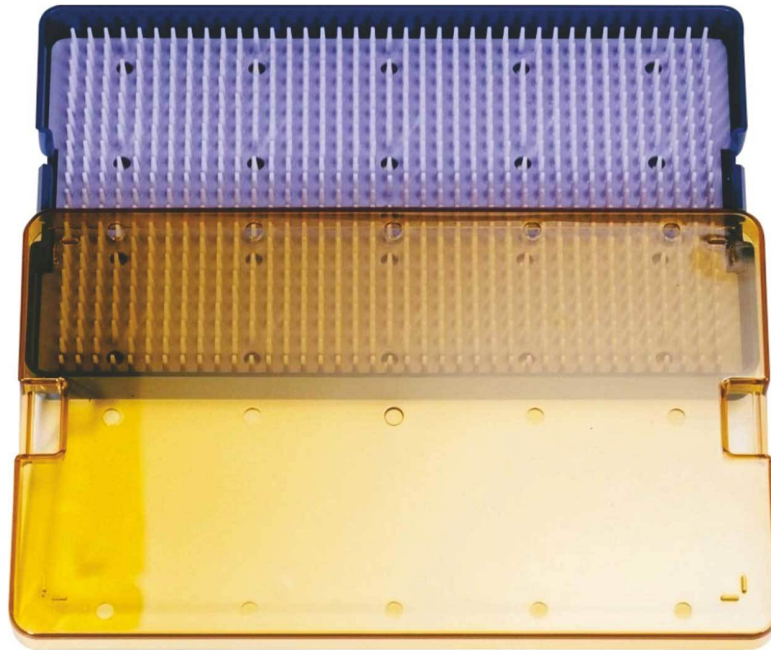

Item #: 101
Name: Sterilization Plastic Box
Available in all sizes



Item #: 102
Name: Sterilization Metal Box
Available in all sizes



OPHTHALMIC INSTRUMENTS

📍 **Address:** Kotli loharan
head marala road sialkot Pakistan.

🌐 **Website :** www.surgicalessence.com

📞 **Viber / Whatsapp**

📞 **Call :** 92 3036029756
92 3415511315

✉ **Email :** info@surgicalessence.com

Infosurgicalessence@gmail.com



www.surgicalessence.com